

GROUND ZERO[®]

GERMAN ENGINEERING

2019/2020



GROUND ZERO[®]

GERMAN ENGINEERING

Sophisticated car audio since 1995

The Rise of the GROUND ZERO Company

GROUND ZERO has been founded back in 1995 by Karl Felix Lautner distributing car audio products "Made in USA" and introduced the revolutionary subwoofers of GZ Engineering USA to the European market in 1997. The following years, the German Company took over the European trademark rights of "GROUND ZERO" and started developing market specific products. Finally, 2003 the GROUND ZERO GmbH took over all global trademarks from the discontinued US company and expanded the distribution to customers worldwide. Today, more than 300 sophisticated audio products developed and designed at the GROUND ZERO in-house engineering department are available in more than 60 countries globally.

Ensuring Superior Quality of GROUND ZERO Products

The GROUND ZERO product range includes speakers, subwoofers, amplifiers and further digital audio equipment for enthusiastic customers. Satisfying high demands and quality, Ground Zero carefully monitors every step of the production starting at the development using top-notch tools and highly accurate measurement equipment such as the laser controlled KLIPPEL[®] system to optimize every detail. Precise amplifier measurement equipment by Audio Precision[®] results in power ratings corresponding to the acknowledged CEA 2006-A standard. Without exceptions, every single product is evaluated by extensive testing and quality control prior to its final production release and market launch.

On the Winner's Side with GROUND ZERO

Many international car audio journals confirm the highest product quality impressing even sophisticated customers. However, the most convincing evidence is provided by the huge amount of GROUND ZERO equipped cars worldwide.

With an outstanding audio performance, they succeed to be part of the winner's circle of European and World SQ and SPL Championships every season.

	HOME AUDIO	4
	REFERENCE	6
	PLUTONIUM	10
	NUCLEAR	14
	URANIUM	18
	HYDROGEN	22
	RADIOACTIVE	26
	TITANIUM	32
	IRIDIUM	36
	COMPETITION	42
	DSP	48
	CAR SPECIFIC	52
	Damping	58
	Accessories	60
	MARINE	64
	Headphones	66
	Product Specifications	67



Many years of experience in development of high quality speaker systems for in-car use has availed creating and evolving the very first and own home audio loudspeakers project having been requested by so many worldwide customers.

The result is a unique audio reproducing concept combining modern and stylish design with sophisticated components within an excellently manufactured speaker enclosure exceeding all expectations.

Thus, even independent trade journals come to an unanimous opinion about this more than just successful debut in the home audio world.

General information

Speaker	Ground Zero The Reference	Evaluation	Design tip	HiFi Test
- Price per couple	around 14.000 euros	Sound	70 %	0,9
- Sales by Ground Zero, Eggenfelden		- Tonal balance	20 %	1,0
- Phone	+49-8095-673830	- Imaging accuracy	15 %	1,0
- Internet	www.ground-zero-audio.com	- Detail resolution	15 %	0,9
		- Spatial reproduction	10 %	0,9
		- Dynamics / Liveliness	10 %	0,8
Features		Lab	15 %	1,0
- Versions	Multilayer lacquer, high gloss black	- Frequency curve	5 %	1,1
- Dimensions (W x H x D in mm)	290 x 1.130 x 650	- Distortion	5 %	0,9
- Weight (in kg)	not specified	- Level consistency	5 %	0,9
- Embodiment	Bass reflex, Downfire			
- Connection	Bi-wiring	Practice	15 %	1,0
- Impedance (in ohms)	4	- Workmanship	5 %	0,8
- Lower midwoofer	internal diameter/cone thickness 2 x 180 / 130 mm coated paper	- Equipment	5 %	1,1
- Tweeter	1 x 28 mm fabric dome	- Operating instructions	5 %	1,0
- Particularities	-			

Conclusion

„What a debut: Ground Zero's first loudspeakers for the home hifi market are a real sensation. Whether it's the extravagant look, the first-class quality of manufacturing or the incredibly room-filling sound with awesome dynamics. The Ground Zero „the Reference“ show a lot of self-confident character and perform acoustically as well as formally - a truly brilliant product on the HiFi market.“



High-end floor standing loudspeaker enclosure with 2-way D'Appolito speaker system

- Drivers – Made in Germany
- Klippel® optimized midwoofer
- Double hand-coated silk dome tweeter
- High quality crossover with exclusive Mundorf® components
- Solid, vented enclosure with piano paint finish
- Efficient down-firing technology
- Deep and dynamic bass reproduction
- Bi-wiring terminal

Model specifications

THE REFERENCE

Power handling: 150 – 300 Watts

Impedance: 3 – 6 ohms

Frequency response: 30 Hz – 25 kHz

Midwoofer: 2x 180 mm / 2x 7" coated paper cone

Tweeter: 28 mm / 1.1" hand-coated silk dome

Crossover type: 18 dB/oct, bi-amping option

Crossover frequency: 1950 Hz (18 dB/oct.)

Dimensions: 1130 x 650 x 290 mm /
44.5" x 25.6" x 11.42"

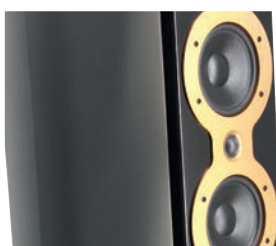

D'Appolito array



Bi-wiring terminal



Drivers - Made in Germany



Down-firing technology

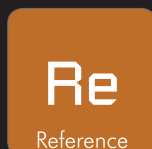

The EISA awarded REFERENCE components obtain the highest attention and care during a long lasting development. Without any compromise, each component is selected from the best ones available on the market.

Highest production quality and the most accurate supervision of every single part ensure not less than perfect performance, ultimate sound quality and workmanship for the highest demanding customer.

Emphasizing the high-end status of the REFERENCE products, each amplifier, speaker and subwoofer is finally certified by GROUND ZERO 's in-house quality department and delivered in a classy, logo-branded wooden box handmade in Germany.



Check our webpage
for more details and 360° view!

Model specifications

GZPA Reference 2PURE
 High End Pure SQ 2-Channel amplifier
 2x 420 / 750 / 1150 W @ 4 / 2 / 1 Ω
 Bridged mode 1x 2700 W Max @ 2 Ω
 Symmetrical dual mono design



GZPA Reference 4PURE
 High End Pure SQ 4-Channel amplifier
 4x 150 / 270 / 425 W @ 4 / 2 / 1 Ω
 Bridged mode 2x 1000 W Max @ 2 Ω
 Symmetrical dual 2 channel design



General information

The designation of the REFERENCE 2PURE and REFERENCE 4PURE amplifiers reveal the essential idea behind: Pure Sound Quality

These two models waive all kind of filters and unnecessary controllers influencing the signal.

Removing these parts during the development process leads to a completely new circuit layout with short and direct signal flow from the input sockets to the speaker terminals.

The components used for these master pieces of analog amplification technology have been selected with highest care opposing any compromises and have even been engineered exclusively for the REFERENCE PURE models.

The power supply has been separated electrically as well as physically leading to an absolute symmetrical layout of the circuit that is the basis for these real dual mono and dual stereo amplifiers.

The amazing output power of up to 1150 Watts per channel provides another contribution to the unbelievable precise and detailed REFERENCE sound, punchy and dynamic as well as warm and enjoyable.

With highest imaginable quality, these amplifiers are setting benchmarks in each category.

- High End Sound quality amplifiers
- Variable Bias setting
- Symmetrical design
- Separated L & R Gain control
- No filters – PURE and direct sound
- Rhodium RCA sockets
- Audio optimized ALPS potentiometers
- High End Sanken transistors
- GZ exclusive Mundorf capacitors
- White LED illuminated PCB
- Plexi glas bottom plate



General information

REFERENCE speakers are designed for demanding high-end music lovers. Accurately hand built in Europe, selected in corresponding pairs and delivered in classy wooden boxes. Midbass and midrange speakers are made from hand-coated, pressed paper cones and hand-spooled copper voice coils, inserted into manually machined aluminum parts of the basket, forming the basis for outstanding high-end sound quality.

The tweeter features a particularly low resonance frequency. The usable wide frequency range of the hand-coated silk dome thus enables astonishingly spatial and precise audio reproduction.



Model specifications

GZPT Reference 28EVO
High End 28 mm / 1.1" tweeter
100 WRMS / 150 WMAX
1.5 – 30 kHz / FS: 600 Hz
2 layer hand coated silk dome
Damped coupled chamber
Chromed aluminum housing
Linearized dual neo magnet

 Made in Germany



GZPM Reference 80
High End 80 mm / 3.15" midrange
80 WRMS / 120 WMAX
150 – 6000 Hz / FS: 107.5 Hz
High flexible Conex spider
Low loss flat rubber surround
Hand assembled aluminum basket
Handmade in Europe



GZMW Reference 180
High End 180 mm / 7.09" midwoofer
100 WRMS / 150 WMAX
40 – 3500 Hz / FS: 56.8 Hz
High flexible Conex spider
Low loss flat rubber surround
Hand assembled aluminum basket
Handmade in Europe



Model specifications

GZPW Reference 250
 High End 250 mm / 10" subwoofer
 500 WRMS / 2x 2 Ω
 31.3 Hz / Qts 0.40
 VAS 36.5 L / 1.29 ft³

 Made in Germany

Common features

For most accurate bass performance, the unique REFERENCE subwoofer comes with a lot of particular solutions, such as a number of linearization parts added to the magnet system optimizing the impedance and eliminating distortion. This exceptional subwoofer has been optimized to perform in small enclosures.

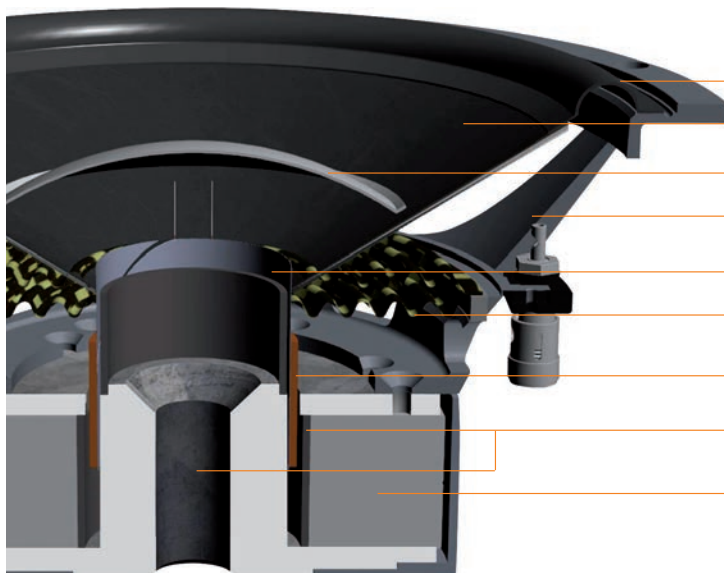

SURROUND
 Light-weight rubber

CONE
 Three layer sandwich
 (Paper - 2 component foam - paper)

DUSTCAP
 Coated highly pressed paper

BASKET
 Resonance free aluminum cast

VOICE COIL FORMER
 High temperature stable glassfiber

SPIDER
 Double-layer BIMAX®
 (Polyester - Cotton)

VOICE COIL
 50 mm / 2" copper voice coil

SHORT CIRCUIT RINGS
 Aluminum rings for impedance linearizing
 and distortion elimination

MOTOR
 Linearized high efficient motor
 with double ferrite magnet



The products of the PLUTONIUM line are suitable for ultimate sound quality, world record SPL levels or extreme low frequency response. To achieve one of these targets, exceptional materials and technologies are applied during the development. The technical, electrical and mechanical skills of the resulting products stand out continuously at worldwide SPL and SQ competitions. The neodymium driven subwoofer sets SPL level benchmarks while the SQ amplifiers have been awarded by EISA for best performance representing numerous car audio test magazines from all around the world.



Check our webpage
for more details and 360° view!

Model specifications

GZPA 2SQ

High performance SQ 2-channel amplifier
 2x 175 / 315 / 500 W @ 4 / 2 / 1 Ω
 Bridged mode 1x 1000 W Max @ 2 Ω



GZPA 4SQ

High performance SQ 4-channel amplifier
 4x 125 / 225 / 350 W @ 4 / 2 / 1 Ω
 Bridged mode 2x 700 W Max @ 2 Ω



General information

The PLUTONIUM series contains two sound quality amplifiers simply leaving no wishes unfulfilled. The 4-channel version has been awarded by the EISA organization as the world's best in-car amplifier 2018/2019.

Features:

- Shielded dual power supply
- High-end sound quality amplifier
- Discretely constructed MOS-FET sections
- 1 ohm stable / 2 ohms stable (bridged)
- Smoothly variable BIAS adjustment
- Variable input sensitivity
- Capsulated potentiometers
- Wide range high pass and low pass filter
- Filter range multiplication switch (x10)
- High resolution response (10 Hz – 50 kHz)
- Soft start delay
- Operation and protection indicator
- Start-Stop capability (9 -16 Volt)
- Overheat and short circuit protection
- Low distortion Burr-Brown operation amps
- Exclusive Mundorf Mcap® capacitors
- High-efficient black anodized heatsink
- White illuminated lasered glass logo plate



General information

The components of the PLUTONIUM line have been developed for highly sophisticated sound quality requests. The drivers are available as a 2- or 3-way system with no passive crossover for full active applications. Each speaker component is available separately for individual setups, as well.

Features:

- High-end speakers for SQ enthusiasts
- Made in Germany and selected in pairs
- Resonance free aluminum cast baskets
- High-tech aluminum & magnesium cones
- Impedance linearizing copper caps
- Powerful Klippel® optimized motors
- High-dynamic sound reproduction



Model Specifications

GZPC 16.3SQ-ACT
 High End 3-way active system
 300 WRMS / 480 WMAX
 Freq. response 30 – 30000 Hz
 Components:
 GZPK 16SQ
 GZPM 80SQX-II
 GZPT 28SX
 Speaker grill

 Made in Germany



GZPC 165SQ-ACT
 High End 2-way active system
 230 WRMS / 360 WMAX
 Freq. response 30 – 24000 Hz
 GZPK 16SQ
 GZPT 28SX
 Speaker grill

 Made in Germany



GZPC 165.2SQF-ACT
 High End 2-way active system
 180 WRMS / 290 WMAX
 Freq. response 30 – 24000 Hz
 Components:
 GZPK 16SQ
 GZPF 40SQ
 Speaker grill

 Made in Germany



PLUTONIUM Speaker components



GZPT 28SX
 High End 28 mm / 1.1" tweeter
 100 WRMS / 150 WMAX

 Made in Germany



GZPF 40SQ
 High End 40 mm / 1.6" full range
 50 WRMS / 80 WMAX

 Made in Germany



GZPM 80SQX-II
 High End 80 mm / 3.15" midrange
 70 WRMS / 110 WMAX

 Made in Germany



GZPK 16SQ
 High End 165 mm / 6.5" midwoofer
 130 WRMS / 210 WMAX

 Made in Germany

Model specifications

GZPW 10SQ
High End sound quality subwoofer
400 W RMS / 2x 2 Ω

Aluminum cast fastening rim
and grill included



General information

GROUND ZERO engineers and product designers were concentrated on developing a brand new high-end sound quality subwoofer. Optimized for small sealed enclosures for highest audiophile expectations, this new 10" SQ model is now available.

Features:

- 10" high-end sound quality subwoofer
- Klippel® optimized (for sealed enclosures)
- Anodized aluminum cone and dust cap
- Solid aluminum cast basket
- Rubber surround
- Copper wire voice coil
- Aluminum cast fastening rim/grill included

PLUTONIUM NEO SPL Subwoofer

Model specifications

GZPW 15NEO-SPL
High power SPL subwoofer
3000 WRMS / 10000 WSPL / 2x 1 Ω



General information

GROUND ZERO introduced the ultimate SPL subwoofer for competition use with the PLUTONIUM series neodymium-driven top-of-the-line 15" model.

Features:

- 15" high power SPL subwoofer
- Multi-piece neodymium motor
- Klippel® optimized
- Carbon fiber mixed cone
- SPL U-shape surround
- Solid aluminum cast basket
- 100 mm / 4" flat wire voice coil
- 4-layer Nomex spider
- Carbon fiber dust cap

PLUTONIUM Xmax Subwoofer

Model specifications

GZPW 15Xmax
High power long stroke subwoofer
6000 WRMS / 2x 1 Ω



General information

The PLUTONIUM series Xmax subwoofer follows in the footsteps of the legendary GZPW 15XQ setting a new benchmark for cone excursions. To realize this, GROUND ZERO uses only components with extremely high power handling and a construction that has never been used before.

Features:

- 15" high power long stroke subwoofer
- Klippel® optimized
- Solid Aluminum cone and dust cap
- Long stroke foam surround
- Solid aluminum cast basket
- 100 mm / 4" flat wire voice coil
- 4-layer Nomex spider



With several particular features of the High End PLUTONIUM line, GROUND ZERO managed to position the NUCLEAR line products at a lower price level.

Nevertheless, the amazingly sounding speakers are partly "Made in Germany".

The subwoofers are predestined for high level audio setups as well as for SPL competition while massive multi-channel and impressively powerful mono amplifiers deliver excellent performance.



Check our webpage
for more details and 360° view!

Model specifications

GZNA 1.2550DXII
 High power mono class D amplifier
 850 / 1500 / 2400 W @ 4 / 2 / 1 Ω
 Linkmode 6200 W Max @ 2 Ω



GZNA 2850XII
 High power 2 channel class AB amplifier
 2x 430 / 800 / 1200 W @ 4 / 2 / 1 Ω
 Bridgemode 1x 2800 W Max @ 2 Ω



GZNA 4330XII
 High power 4 channel class AB amplifier
 4x 200 / 350 / 550 W @ 4 / 2 / 1 Ω
 Bridgemode 2x 1300 W Max @ 2 Ω



General information

The NUCLEAR line of massive multi-channel and impressively powerful mono amplifiers deliver ultimate performance providing a variety of important features for sound adjustment.

Features:

- High power amplifiers
- 1 ohm stable high current circuit
- Stabilized dual power supplies
- SMD technology
- Gold plated terminals and RCA sockets
- Bass remote control
- Subsonic filter
- HP / LP / BP filter
- Phaseshift
- Bass Boost

General information

The NUCLEAR line includes a wide range of speaker components available separately in pairs. This way, a lot of individual combinations are possible. More than that, GROUND ZERO offers some perfectly matching 2-way and 3-way sets for active and passive applications.

Features:

- High quality speakers for SQ enthusiasts
- Selected in matching pairs
- Resonance free aluminum cast baskets
- Lightweight coated paper cones
- Impedance linearizing copper caps
- Powerful Klippel® optimized motors
- Natural sound performance



GZTH 25B
Optional tweeter housing for GZNT 22SQ

Model specifications

GZNC 165.3SQ-ACT
High End 3-way active system
150 WRMS / 250 WMAX
40 – 28000 Hz
Components:
GZNK 165SQ
GZNM 80SQ
GZNT 25SQ
Speaker grill

Made in Germany



GZNC 165.2SQ-ACT
High End 2-way active system
150 WRMS / 250 WMAX
40 – 28000 Hz
Components:
GZNK 165SQ
GZNT 25SQ
Speaker grill

Made in Germany



GZNC 1650SQ
High End 2-way passive system
150 WRMS / 250 WMAX
40 – 28000 Hz / Cut-off 2800 Hz
Components:
GZNK 165SQ
GZNT 25SQ
High quality crossover
Speaker grill

Made in Germany



NUCLEAR Speaker components



GZNT 22SQ
High quality tweeter
22 mm / 0.87"
80 WRMS / 130 WMAX



GZNT 25SQ
High quality tweeter
25 mm / 1"
80 WRMS / 130 WMAX

Made in Germany



GZNF 50SQ
High quality full range
50 mm / 2"
50 WRMS / 80 WMAX



GZNM 80SQ
High quality midrange
80 mm / 3.15"
60 WRMS / 100 WMAX

Made in Germany



GZNK 165SQ
High End midwoofer
165 mm / 6.5"
130 WRMS / 200 WMAX

Made in Germany

Model specifications

GZNW 38NEO-SPL
 High power SPL subwoofer
 2500 WRMS / 5000 WSPL / 2x 1 Ω

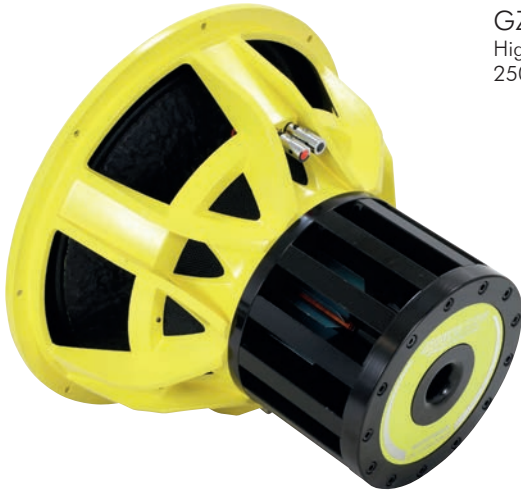

General information

The NUCLEAR line neodymium-driven SPL subwoofer shares some of the features of the PLUTONIUM series top subwoofer. However, due to a lower resonance frequency and more linear design, this model performs perfectly in street applications, as well.

Features:

- 15" high power SPL subwoofer
- Multi-piece neodymium motor
- Klippel® optimized
- Reinforced paper cone and dust cap
- U-shape high roll SPL surround
- Solid aluminum cast basket
- 75 mm / 3" 8-layer aluminum voice coil
- 3-layer Nomex spider

NUCLEAR Xmax subwoofers

Model specifications

GZNW 12Xmax
 High performance long stroke subwoofer
 3000 WRMS / 2x 1 Ω

GZNW 15Xmax
 High performance long stroke subwoofer
 4000 WRMS / 2x 1 Ω



General information

The NUCLEAR line Xmax subwoofers share some of the features of the PLUTONIUM series top subwoofer and expand the line of high excursion models providing excellent low bass performance.

Features:

- High power low bass subwoofers
- Klippel® optimized
- Aluminum cone and dust cap
- Long stroke compound surround
- Solid aluminum cast basket
- 75 mm / 3" CCA round wire voice coil
- 4-layer Nomex spider

NUCLEAR Xflex subwoofers

Model specifications

GZNW 12SPL-Xflex
 High performance
 SPL subwoofer
 2500 WRMS / 4500 WSPL
 2x 1 Ω

GZNW 15SPL-Xflex
 High performance
 SPL subwoofer
 3000 WRMS / 5500 WSPL
 2x 1 Ω

GZNW 18SPL-Xflex
 High performance
 SPL subwoofer
 3000 WRMS / 6500 WSPL
 2x 1 Ω



General information

Paired with the yellow colored surround stitch and an ultra-solid as well as perfectly ventilated aluminum cast basket, the SPL-Xflex subwoofers with powerful ferrite motor are predestined for high level audio setups. The particular Xflex high roll surround combines high excursion capability with flexibility for low frequency music reproduction.

Features:

- High performance SPL music subwoofer
- Klippel® optimized
- Reinforced paper cone
- SPL high-roll Xflex surround
- Solid aluminum cast basket
- 75 mm / 3" CCA round wire voice coil
- 4-layer progressive spider
- IMPP dust cap with 3D structure logo



Each product of the URANIUM line-up has been developed carefully to fulfill the demands of music enthusiasts with high audiophile expectations at a reasonable price level. Applying all of Ground Zero's sound quality competition experience while tuning the product details carefully, results in emotional and amazing audio reproduction. The distinguished amplifiers point out the main purpose by their designation: SQ beyond the average!



Check our webpage
for more details and 360° view!

Model specifications

GZUA 2.250SQ-PLUS
 Sound quality 2 channel amplifier
 2x 180 / 320 / 500 W @ 4 / 2 / 1 Ω
 Bridged mode 1x 1200 W Max @ 2 Ω
 Bass remote control included



GZUA 4.150SQ-PLUS
 Sound quality 4 channel amplifier
 4x 110 / 190 W @ 4 / 2 Ω
 Bridged mode 2x 460 W Max @ 4 Ω



GZUA 6.200SQ-PLUS
 Sound quality 6 channel amplifier
 4x 110 / 160 W Channel 1-4 @ 4 / 2 Ω
 2x 160 / 280 W Channel 5-6 @ 4 / 2 Ω
 2x 320 W Channel 1-4 @ 4 Ω bridged mode
 1x 560 W Channel 5-6 @ 4 Ω bridged mode



General information

The distinguished URANIUM SQ amplifiers point out the main purpose by their designation. Particular features like the unique variable BIAS setting increase the sound quality to the next level while highly accurate and variable wide band filters allow various combinations of full active speaker setups.

Features:

- Sound quality amplifiers
- Variable BIAS setting
- Class A/B technology
- Variable active crossover
- Stable power supply
- Gold-plated connectors
- Flat heatsink with engraved GZ lettering

Variable BIAS setting

The BIAS setting affects the operation mode of the amplifier.

It is continuously adjustable from <MIN> (actual Class A/B mode) to <MAX> (close to Class A mode). An amplifier in Class A mode sounds warm and creates a pleasant atmosphere. Compared to that, the Class A/B mode of an amplifier sounds more direct and dynamic. Depending on the BIAS setting, the current consumption of the amplifier is growing the closer the operation comes to the Class A mode leading to an increased temperature. The power rating however, remains identical. The BIAS can be set using the control on the bottom of the amplifier for each pair of channels, independently.

General information

Using outstanding materials for the cones and accurate tuning, these speakers provide an amazing sound quality performance. Apart from the separately available components, GROUND ZERO offers some models compiled to high quality passive speaker systems, as well.

Features:

- High-tech speakers for SQ-applications
- Resonance free Euro-DIN alu cast baskets
- WFWC® cone with woven wooden fibre
- LDW® surround (SQX models)
- Variable 12 dB/oct crossover
- Bi-amping option (SQX models)
- Linearized, Klippel® optimized motors
- Universal 4 Ω impedance
- Speaker protection grill
- Harmonic sound performance



Model specifications

GZUC 65.3SQX

Sound quality 3-way semi-active system
220 WRMS / 350 WMAX
Freq. response 40 – 25000 Hz
Cutoff 2800 Hz (Midrange / Tweeter)
Components:
GZUC 650SQX
GZUF 60SQX



GZUC 650SQX

Sound quality 2-way passive system
140 WRMS / 220 WMAX
Freq. response 40 – 25000 Hz
Cutoff 2800 Hz (Kick / Tweeter)
Components:
GZUK 65SQX
GZUT 25SQX



GZUC 650SQ-II

Sound quality 2-way passive system
130 WRMS / 210 WMAX
Freq. response 40 – 24000 Hz
Cutoff 2800 Hz (Kick / Tweeter)

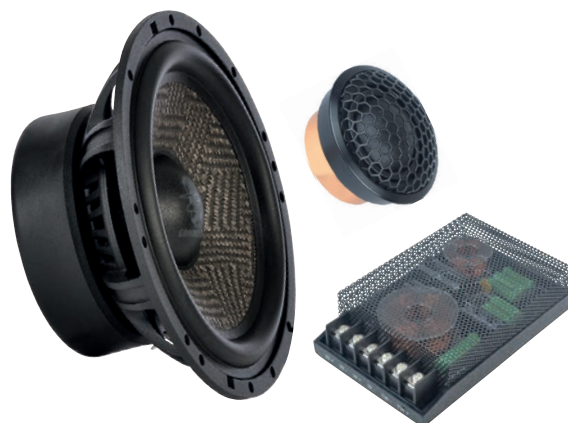

URANIUM SQX Speaker components



GZUT 25SQX
Sound quality 25 mm / 1" tweeter
70 WRMS / 120 WMAX



GZUF 60SQX
Sound quality full range speaker
50 WRMS / 80 WMAX



GZUK 65SQX
Sound quality 165 mm / 6.5" midwoofer
130 WRMS / 210 WMAX

Model specifications

General information



GZUW 8SQX
Sound quality subwoofer
300 WRMS / 2x 2 Ω



GZUW 10SQX
Sound quality subwoofer
450 WRMS / 2x 2 Ω



GZUW 12SQX
Sound quality subwoofer
600 WRMS / 2x 2 Ω

High-performance SQ speaker setups require equivalent low frequency extension. The URANIUM line of SQX subwoofers match perfectly and offer various options for individually calculated custom enclosures.

Features:

- Sound quality subwoofer
- Klippel® optimized
- Scooped and pressed paper cone
- U-shape foam surround
- Solid aluminum cast basket
- 50 mm / 2" copper voice coil
- Audiophile Polycot spider
- Reinforced paper dust cap

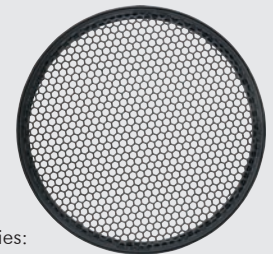

Optional accessories:
GZPG 250G protection grill

URANIUM Enclosures

Model specifications

General information



GZUB 600XACTII
Flat active subwoofer
16 cm / 6" woofer
Dual voice coil
100 WRMS / 160 WMAX



GZUB 800XACTII
Flat active subwoofer
20 cm / 8" woofer
Triple voice coil
120 WRMS / 180 WMAX



GZUB 1000XACTII
Flat active subwoofer
25 cm / 10" woofer
Triple voice coil
150 WRMS / 210 WMAX

Fulfilling the customer's desire for lower frequency response and compact bass upgrades, GROUND ZERO offers a line of aluminum cast active subwoofers. Each of these active under-seat subwoofers comes with a very flat housing, enabling the installer to find a place even at the most limited space.

Features:

- High quality active flat subwoofer
- High-power integrated amplifier
- Solid aluminum cast housing
- High-level input
- Automatic turn-on function
- Low pass filter
- Phase correction
- Incl. wired remote control & wiring kit



The HYDROGEN line satisfies all demands of highly sophisticated customers.

Amazing performance, great sound quality and much higher SPL than imagined.

The subwoofers have been developed to handle a huge amount of input power reaching extremely high bass levels to be used successfully under competition conditions.

Especially for limited installation space, three extremely small amplifiers have been added to the line of well-known existing high power models.



Check our webpage
for more details and 360° view!

Model Specifications

GZHA 1.1850DXII
 High power mono class D amplifier
 700 / 1200 / 1850 W @ 4 / 2 / 1 Ω
 Linkmode 4800 W Max @ 2 Ω



GZHA 2400XII
 High power 2 channel class AB amplifier
 2x 270 / 480 / 750 W @ 4 / 2 / 1 Ω
 Bridged mode 1x 1800 W Max @ 2 Ω



GZHA 4200XII
 High power 4 channel class AB amplifier
 4x 140 / 200 @ 4 / 2 Ω
 Bridged mode 2x 500 W Max @ 4 Ω



Common features

The massive strand-cast aluminum heat-sink of the HYDROGEN XII amplifiers is matching the NUCLEAR line amplifiers. The affordable 2- and 4-channel class AB models and the class D mono version feature latest SMD technology and a stabilized dual power supply.

Features:

- High power amplifier
- Stabilized dual power supply
- SMD components
- Class A/B technology
- Variable active crossover
- Subsonic filter
- Bass boost
- Phase shift
- Large terminals
- Solid heatsink with engraved GZ lettering
- Wired bass remote control included

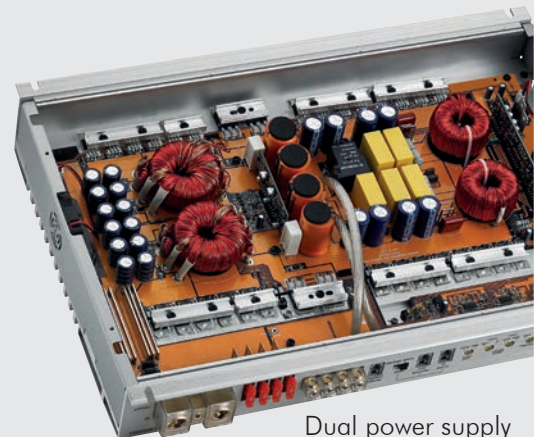

Dual power supply

General information

Especially for limited installation space, GROUND ZERO offers the compact sized HYDROGEN MINI fullrange class D amplifiers. Meeting all requirements, a 2-channel, a 4-channel and a 5-channel model is available in a small-sized black-anodized heatsink. In addition, two powerful mono amplifiers complete the line-up.

Features:

- Compact sized amplifiers
- High-efficient class D technology
- SMD components
- Variable active crossover
- Bass boost & phase shift (not GZHA MINI FIVE)
- Stabilized power supply
- Large terminals
- Solid heatsink with engraved GZ lettering
- Bass remote control included (not for GZHA MINI FOUR))
- High-level input with auto-on function
- Link mode for two amplifiers (GZHA MINI ONE / ONE-K)

Model specifications

GZHA MINI ONE

Compact mono subwoofer amplifier
220 / 390 / 630 W @ 4 / 2 / 1 Ω
Link mode 1500 W Max @ 2 Ω



GZHA MINI ONE-K

Compact mono subwoofer amplifier
340/600/1000 W RMS @ 4 / 2 / 1 Ω
Link mode 2300 W Max @ 2 Ω



GZHA MINI TWO

Compact 2 channel fullrange amplifier
2x 130 / 230 W @ 4 / 2 Ω
Bridged mode 1x 550 W Max @ 2 Ω



GZHA MINI FOUR

Compact 4 channel fullrange amplifier
4x 80 / 130 @ 4 / 2 Ω
Bridged mode 2x 320 W Max @ 4 Ω



GZHA MINI FIVE

Compact 5 channel fullrange amplifier
4x 75/125/- & 190/320/500 W RMS @ 4 / 2 / 1 Ω



Model specifications

General information



GZHW 16SPL
High quality SPL subwoofer
1000 WSPL / 2x 2 Ω
50 mm / 2" voice coil

● ● Available in yellow or green color



GZHW 20SPL
High quality SPL subwoofer
1500 WSPL / 2x 1 Ω
63 mm / 2.5" voice coil

● ● Available in yellow or green color



GZHW 25SPL
High quality SPL subwoofer
1500 WSPL / 2x 1 Ω
63 mm / 2.5" voice coil

● ● Available in yellow or green color



GZHW 30SPL
High quality SPL subwoofer
3000 WSPL / 2x 1 Ω
75 mm / 3" voice coil

● ● Available in yellow or green color



GZHW 38SPL
High quality SPL subwoofer
3500 WSPL / 2x 1 Ω
75 mm / 3" voice coil

● ● Available in yellow or green color

The HYDROGEN SPL subwoofer line-up contains a great variety of models in many different sizes for various demands. Massive aluminum cast baskets and a lot of further technologies enhance the reachable SPL level. For an individual setup each model is available in typical yellow or in green. GROUND ZERO offers the 12" model in pink color for custom installations.

Features:

- High power SPL subwoofers
- Fiber reinforced paper cone
- IMPP dust cap with 3D structure logo
- Multilayer foam U-Shape SPL surround
- High temperature copper US-made vc
- Progressive 2-layer spiders
- Massive aluminum cast basket
- Powerful street bass and SPL performance





The RADIOACTIVE line offers a wide range of exceptional high efficient speakers and subwoofers for daily and SPL use. During the development GROUND ZERO focused especially on natural and dynamical audio reproduction of digitally compressed music.

Apart from some powerful amplifiers, the line contains extremely small amplifiers for limited space environments.



Check our webpage
for more details and 360° view!

Model specifications

General information



GZRA 1.1650DX
 High power mono class D amplifier
 650 / 1250 / 1800 W @ 4 / 2 / 1 Ω
 Linkmode 4600 W Max @ 2 Ω
 Stabilized dual power supply

The wide range of high power amplifiers offer amazing output power up to 6000 Watts in link mode wrapped in a stylish titanium color heatsink containing a wide range of appropriate features for perfect audio adjustment.

Features:

- High power amplifiers
- Stabilized power supplies
- Massive aluminum heatsinks
- High-gloss acrylic glass inlay
- Covered connectors
- Variable active crossover
- Subsonic filter
- Phase shift (mono amplifiers)
- Bass boost
- Bass remote (mono and 2 channel)

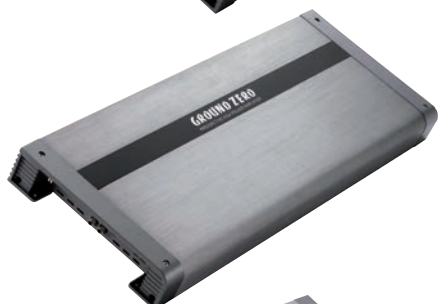

GZRA 1.2500DX
 High power mono class D amplifier
 750 / 1400 / 2200 W @ 4 / 2 / 1 Ω
 Linkmode 6000 W Max @ 2 Ω
 Stabilized triple power supply



GZRA 2255X
 High power 2 channel class AB amplifier
 2x 150 / 250 @ 4 / 2 Ω
 Bridged mode 600 W Max @ 4 Ω



GZRA 4230X
 High power 4 channel class AB amplifier
 4x 140 / 230 @ 4 / 2 Ω
 Bridged mode 2x 550 W Max @ 4 Ω

RADIOACTIVE MICRO Amplifiers

Model specifications

General information



GZRA MICRO ONE
 Compact mono class D amplifier
 220 / 350 W @ 4 / 2 Ω

The GZRA MICRO series amplifiers allow space-saving installation and offer all necessary filters for the sound setup.

Features:

- Extremely compact amplifiers
- High-efficient class D technology
- 2 ohms stable SMD circuit
- Wide band crossover filters
- High-level inputs
- Automatic turn-on function
- Variable active crossover
- Bass boost (MICRO ONE)
- Bass remote (MICRO ONE)



GZRA MICRO FOUR
 Compact 4 channel class D amplifier
 4x 60 / 100 @ 4 / 2 Ω
 Bridged mode 2x 250 W Max @ 4 Ω

Optionally available accessory
GZCS 4.0BMW-CONNECT
 Car specific wiring harness
 suitable for BMW and MINI

General information

The new RADIOACTIVE SQ speaker systems have been developed for highly demanding listeners. Introducing a brand new coated silk dome tweeter and including a high-grade passive crossover with various options, the passive set is available as a 2- or 3-way package.

Features:

- High-dynamic SQ speakers
- Black anodized aluminum cone
- Coated silk dome tweeter
- High-grade 12 dB/oct passive crossover
- High-efficient 3 Ω impedance
- Linearizing copper cap
- Klippel® optimized motor
- Speaker grill

Model specifications

GZRC 165.3SQ
 High-dynamic SQ 3-way passive system
 150 WRMS / 230 WMAX
 Freq. response 35 – 24000 Hz
 Components:
 GZRK 165SQ
 GZRM 80SQ
 GZRT 25SQ



GZRC 165.2SQ
 High-dynamic SQ 2-way passive system
 120 WRMS / 190 WMAX
 Freq. response 35 – 25000 Hz
 Components:
 GZRK 165SQ
 GZRT 25SQ



RADIOACTIVE IV Speaker systems

General information

The RADIOACTIVE IV speaker systems have been Particular materials used for the mid woofer and the tweeter enhance the performance especially when listening to compressed music files.

Features:

- High-efficient speakers
- Aluminum cone for high precision
- Titanium dome tweeter
- In-line 12 dB/oct crossover
- High-efficient 3 Ω impedance
- Linearizing copper cap
- Klippel® optimized motor
- Slant tweeter housing
- Speaker grill

Model specifications

GZRC 130AL-IV
 High-efficient 2-way passive system
 100 WRMS / 160 WMAX
 Freq. response 60 – 26000 Hz



GZRC 165AL-IV
 High-efficient 2-way passive system
 120 WRMS / 190 WMAX
 Freq. response 35 – 26000 Hz
 Components:
 GZRK 16AL
 GZRT 25T



GZTH 25B
 Included



Model specifications

General information



GZRC 100NEO-IV
High-efficient 2-way flat passive system
80 WRMS / 120 WMAX
Freq. response 80 – 26000 Hz



GZRC 165NEO-IV
High-efficient 2-way flat passive system
110 WRMS / 170 WMAX
Freq. response 50 – 26000 Hz
Components:
GZMW 165X-NEO
GZRT 25T



GZRC 200NEO-IV
High-efficient 2-way flat passive system
120 WRMS / 190 WMAX
Freq. response 35 – 26000 Hz

Features:

- High-efficient flat speakers
- Low installation depth
- Lightweight coated paper cones
- Titanium dome tweeter
- In-line 12 dB/oct crossover
- High-efficient 3 Ω impedance
- Klippel® optimized neodymium motor
- Slant tweeter housing
- Speaker grill

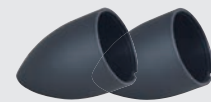

GZTH 25B
Included

RADIOACTIVE Speaker components



GZRT 25T
High-dynamic tweeter
70 WRMS / 110 WMAX
Freq. response 3 – 26 kHz
Titanium dome



GZRT 25SQ
High-dynamic SQ tweeter
70 WRMS / 110 WMAX
Freq. response 3 – 25 kHz
Coated silk dome



GZRM 80SQ
High quality SQ midrange
50 WRMS / 80 WMAX
Freq. response 160 – 4000 Hz
Aluminum cone



GZRK 16SQ
High-dynamic 165 mm / 6.5" SQ midwoofer
110 WRMS / 160 WMAX



GZRK 16AL
High-efficient 165 mm / 6.5" midwoofer
110 WRMS / 160 WMAX



GZMW 165X-NEO
High-efficient flat 165 mm / 6.5" midwoofer
90 WRMS / 140 WMAX

General information

The RADIOACTIVE coaxial speakers satisfy the request for dynamical and high-efficient audio reproduction. Aluminum cones used for the mid woofers compared with the PEI tweeter enhance the performance especially when listening to compressed music files.

Features:

- High-efficient coaxial speakers
- Aluminum cone for high precision
- Rubber surround
- Resonance free steel basket
- High-efficient 3 Ω impedance
- 13 mm / 0.51" Mylar tweeter
- 50 mm / 2" Mylar midrange (GZRF 69AL)
- Tweeter and overload protection
- Speaker grill

Model specifications

GZRF 40AL

High-efficient 2-way coaxial speaker
70 WRMS / 110 WMAX
Freq. response 70 – 25000 Hz



GZRF 52AL

High-efficient 2-way coaxial speaker
80 WRMS / 120 WMAX
Freq. response 60 – 25000 Hz



GZRF 65AL

High-efficient 2-way coaxial speaker
100 WRMS / 140 WMAX
Freq. response 50 – 25000 Hz



GZRF 69AL

High-efficient 3-way coaxial speaker
130 WRMS / 200 WMAX
Freq. response 40 – 25000 Hz



Speaker grill included

Model specifications

GZRW 10XSPL
High power SPL subwoofer
800 WRMS / 1200 WSPL
2x 2 Ω

GZRW 12XSPL
High power SPL subwoofer
1000 WRMS / 1500 WSPL
2x 2 Ω

GZRW 15XSPL
High power SPL subwoofer
1200 WRMS / 1800 WSPL
2x 2 Ω



General information

RADIOACTIVE SPL subwoofers include some particular technologies for SPL use at a very reasonable price. The right choice for dedicated SPL competition rookies.

Features:

- High power SPL subwoofers
- Fiber reinforced paper cone
- Multilayer foam U-Shape SPL surround
- High temperature US-made voice coils
- Progressive double layer spiders
- Ultimate choice for SPL-Rookies

RADIOACTIVE Street Subwoofers

Model specifications

GZRW 30-D2
High power subwoofer
800 WRMS / 2x 2 Ω

GZRW 38-D2
High power subwoofer
1000 WRMS / 2x 2 Ω



General information

Using most of the particular features previously developed for the SPL subwoofers, the street versions have been equipped with a large long stroke surround and a special spider to reduce the resonance frequency for daily music reproduction.

Features:

- Powerful low bass subwoofers
- Fiber reinforced paper cone
- Multilayer foam U-Shape surround
- High temperature copper voice coil
- High excursion single layer spider
- Perfect for daily use

RADIOACTIVE Flat Subwoofer

Model specifications

GZRW 8FL
High quality 200 mm / 8" flat woofer
150 WRMS / 250 WMAX / 1x 2 Ω
Freq. Response 30 – 600 Hz



Available accessory
X-GZRW 8FL Grill

General information

This particular subwoofer can be used when installation space is limited.

Features:

- High-strength, extremely flat IMPP Cone
- Aluminum dust cap
- 36 mm / 1.42" copper voice coil
- Rubber surround
- Nomex spider
- Extremely low installation depth
- Powerful free air kick woofer application



The products of the TITANIUM line combine premium quality and high efficiency. A wide range of dedicated speakers meet most of the customer's need. The amplifiers are equipped with sophisticated technology and encased by a posh heat-sink with brushed titanium color surface. Especially for your trucks or bus, GROUND ZERO offers two models as a 24-Volt version.



Check our webpage
for more details and 360° view!

Model specifications

General information



GZTA 1.1200DX-II
High quality mono class D amplifier
400 / 800 / 1300 W @ 4 / 2 / 1 Ω
Linkmode 3000 W Max @ 2 Ω



GZTA 1.800DX-II
High quality mono class D amplifier
350 / 550 / 850 W @ 4 / 2 / 1 Ω
Linkmode 2000 W Max @ 2 Ω



GZTA 4125X-II
High quality 4 channel class AB amplifier
4x 90 / 130 @ 4 / 2 Ω
Bridged mode 2 x 320 W Max @ 4 Ω

GZTA 4125X-II 24V
Stabilized 24 Volt power supply



GZTA 5120X-II
High quality 5 channel class AB amplifier
4x 50 + 180 W @ 4 Ω
4x 70 + 260 W @ 2 Ω

The products of the TITANIUM line combine premium quality and high efficiency. The amplifiers are equipped with sophisticated technology and encased by a posh heatsink with brushed titanium color surface.

Features:

- High power amplifiers
- Stabilized power supplies
- Variable active crossover
- Subsonic filter
- Phaseshift (mono amplifiers)
- Bass Boost
- Massive aluminum heatsinks
- High-gloss acrylic glass inlay
- Covered connectors
- Bass remote included (not for 4 channel)



Especially for trucks, GROUND ZERO offers two models of the TITANIUM amplifier line-up as a 24-Volt version.



GZTA Bassremote
Optional Bassremote for
GZIA, GZTA, GZRA, GZHA and GZNA Amps

TITANIUM Speaker systems

General information

The TITANIUM line contains the lately introduced new range of component speaker systems with yellow color 3D-HQPP cone. Each of the available 2- and 3-way passive systems comes with a soft dome tweeter and an installer friendly crossover.

Features:

- High-efficient component systems
- 3D-HQPP cone
- Rubber surround
- Resonance free steel basket
- High-efficient 3 Ω impedance
- 19 mm / 0.75" soft dome tweeter
- Speaker grill



Hexagon speaker grill included (GZTC 165.3)

Model specifications

GZTC 130

High quality 2-way passive speaker system
80 WRMS / 130 WMAX
Freq. response 60 – 22000 Hz
In-line crossover

GZTC 165

High quality 2-way passive speaker system
100 WRMS / 150 WMAX
Freq. response 50 – 22000 Hz
In-line crossover

GZTC 165.3

High quality 3-way passive speaker system
120 WRMS / 180 WMAX
Freq. response 50 – 22000 Hz
High quality crossover



TITANIUM Coaxial speakers

General information

High efficiency coaxial speakers of the TITANIUM line offer a great value sound upgrade for OEM or aftermarket head units with the significant yellow 3D-HQPP cone.

Features:

- High-efficient coaxial speakers
- 3D-HQPP cone
- Rubber surround
- Resonance free steel basket
- High-efficient 3 Ω impedance
- 13 mm / 0.51" Mylar tweeter
- 55 mm / 2.2" Mylar midrange (GZTF 69)
- Speaker grill



Speaker grill included

Model specifications

GZTF 10

High quality 2-way coaxial speaker system
70 WRMS / 100 WMAX
Freq. response 70 – 22000 Hz

GZTF 13

High quality 2-way coaxial speaker system
80 WRMS / 110 WMAX
Freq. response 60 – 22000 Hz

GZTF 16

High quality 2-way coaxial speaker system
90 WRMS / 130 WMAX
Freq. response 50 – 22000 Hz

GZTF 69

High quality 3-way coaxial speaker system
130 WRMS / 190 WMAX
Freq. response 40 – 22000 Hz



Model specifications

General information



GZTB 20ACT
Flat active subwoofer
20 cm / 8" woofer
100 WRMS / 160 WMAX
Plastic injection enclosure



GZTB 25ACT
Flat active subwoofer
25 cm / 10" woofer
100 WRMS / 160 WMAX
Plastic injection enclosure

Fulfilling the customer's desire for lower frequency response and compact bass upgrades, GROUND ZERO offers two affordable active subwoofers in the TITANIUM line with a plastic-injection housing. Each of these under-seat subwoofers comes with a flat housing, enabling the installer to find a place even at the most limited space.



Bass remote included

TITANIUM Flat subwoofers

Model specifications

General information



GZTW 10F
High quality flat subwoofer
300 WRMS / 2x 2 Ω
Mounting depth 88 mm / 3.46"



GZTW 12F
High quality flat subwoofer
350 WRMS / 2x 2 Ω
Mounting depth 97.5 mm / 3.84"

When space is limited, special solutions are required. That's why GROUND ZERO's offers two particularly flat subwoofers in the TITANIUM line.

Features:

- Extremely flat IMPP cone
- Resonance free steel basket
- Aluminum dustcap
- Push terminal

TITANIUM Passive enclosure

Model specifications

General information



GZTB 120F
High quality extra flat subwoofer
350 WRMS / 2x 2 Ω
Sealed MDF enclosure

The sealed enclosure is equipped with the flat TITANIUM 12" subwoofer, fits perfectly for trunk installations with through-loading system and requires just a modest amount of space.



Representing the entry level of GROUND ZERO, the IRIDIUM line offers a lot of useful features and an amazing performance.

The range contains a variety of affordable amplifiers, speakers and subwoofers for the daily use and for SPL purpose. These are available as single drivers for custom-built applications as well as in loaded passive and active enclosures.



Check our webpage
for more details and 360° view!

Model specifications

General information



GZIA 1.600HPX-II
 High quality mono class AB amplifier
 230 / 400 / 600 W @ 4 / 2 / 1 Ω
 Bass remote control included



GZIA 1.1000DXII
 High quality mono class D amplifier
 350 / 650 / 1000 W @ 4 / 2 / 1 Ω
 Bass remote control included



GZIA 1.1450DXII
 High quality mono class D amplifier
 400 / 750 / 1250 W @ 4 / 2 / 1 Ω
 Bass remote control included



GZIA 2080HPX-II
 High quality 2 channel class AB amplifier
 2x 60 / 80 @ 4 / 2 Ω
 Bridged mode 240 W Max @ 4 Ω



GZIA 2130HPX-II
 High quality 2 channel class AB amplifier
 2x 85 / 130 @ 4 / 2 Ω
 Bridged mode 320 W Max @ 4 Ω
 Bass remote control optional



GZIA 2235HPX-II
 High quality 2 channel class AB amplifier
 2x 150 / 235 @ 4 / 2 Ω
 Bridged mode 540 W Max @ 4 Ω
 Bass remote control optional



GZIA 4115HPX-II
 High quality 4 channel class AB amplifier
 4x 70 / 115 @ 4 / 2 Ω
 Bridged mode 2x 250 W Max @ 4 Ω

The range of amplifiers contains a variety of affordable models for the daily use and for SPL purpose. The feature list includes the most important functions like high-level input with auto turn-on or a remote control for the low impedance stable mono amplifiers.

Features:

- 4 Ω / 2 Ω stable stereo
- 1 Ω stable (mono amplifiers)
- Power & Protection indicator
- Bass Boost (mono amplifiers)
- Variable active crossover
- High level input with Auto-on
- Adjustable input sensitivity
- Soft delayed remote turn-on
- Thermal / Short / Overload protection



GZTA Bassremote
 Optional Bassremote for
 GZIA, GZTA, GZRA, GZHA and GZNA Amps

IRIDIUM Speaker systems



GZIC 13X
High quality 2-way passive system
90 WRMS / 140 WMAX
Freq. response 60 – 20000 Hz
19 mm / 0.75" softdome tweeter



GZIC 16X
High quality 2-way passive system
100 WRMS / 150 WMAX
Freq. response 50 – 20000 Hz
19 mm / 0.75" softdome tweeter



GZIC 400FX
High quality 2-way flat passive system
60 WRMS / 100 WMAX
Freq. response 70 – 20000 Hz
19 mm / 0.75" softdome tweeter



GZIC 650FX
High quality 2-way flat passive system
100 WRMS / 140 WMAX
Freq. response 50 – 20000 Hz
19 mm / 0.75" softdome tweeter

IRIDIUM Coaxial speakers



GZIF 40X
High quality 2-way coaxial speaker
60 WRMS / 100 WMAX
Freq. response 80 – 20000 Hz
13 mm / 1" Mylar tweeter



GZIF 52X
High quality 2-way coaxial speaker
70 WRMS / 110 WMAX
Freq. response 60 – 20000 Hz
13 mm / 0.51" Mylar tweeter



GZIF 65X
High quality 2-way coaxial speaker
80 WRMS / 120 WMAX
Freq. response 50 – 20000 Hz
13 mm / 1" Mylar tweeter



GZIF 69X
High quality 3-way coaxial speaker
120 WRMS / 180 WMAX
Freq. response 40 – 20000 Hz
13 mm / 0.51" Mylar tweeter
50 mm / 2" Mylar midrange



GZIF 4001FX
High quality 2-way flat coaxial speaker
50 WRMS / 90 WMAX
Freq. response 80 – 20000 Hz
13 mm / 0.51" Mylar tweeter



GZIF 5201FX
High quality 2-way flat coaxial speaker
60 WRMS / 100 WMAX
Freq. response 70 – 20000 Hz
13 mm / 0.51" Mylar tweeter



GZIF 6501FX
High quality 2-way flat coaxial speaker
70 WRMS / 110 WMAX
Freq. response 60 – 20000 Hz
13 mm / 0.51" Mylar tweeter

Tweeters



GZHT 19X
High quality 19 mm / 0.75" tweeter
40 WRMS / 70 WMAX
3.5 – 20 kHz / FS: 1650 Hz
Coated silk dome
Ferrofluid cooling



GZHT 25X
High quality 25 mm / 1" tweeter
60 WRMS / 100 WMAX
3 – 20 kHz / FS: 1600 Hz
Coated silk dome
Ferrofluid cooling

Model specifications

General information



GZIW 10SPL
High power SPL subwoofer
700 WSPL / 2x 2 Ω



GZIW 12SPL
High power SPL subwoofer
1000 WSPL / 2x 2 Ω

● ● ● Available in yellow, green or pink color

The IRIDIUM line contains a 10" and a 12" SPL model. The larger version is available in pink or in green color as a special edition to fit perfectly the individual needs of our customers.



IRIDIUM Street Subwoofers

Model specifications

General information



GZIW 165X-II
High quality subwoofer
150 WRMS / 4 Ω



GZIW 200X-II
High quality subwoofer
150 WRMS / 4 Ω



GZIW 250X-II
High quality subwoofer
250 WRMS / 4 Ω



GZIW 300X-II
High quality subwoofer
350 WRMS / 4 Ω

The IRIDIUM street subwoofers with a single 4 Ω voice coil, long stroke rubber surround and IMPP cone are perfect for daily use.

Features:

- Stable IMPP cone
- U-shape rubber surround
- High power copper voice coil
- Audiophile PC spider
- Push terminal
- Woven-in lead wires
- Resonance free steel basket
- 3D dustcap logo
- Rubber gasket

General information

A subwoofer can cover all demands on bass reproduction in a suitable housing. The IRIDIUM series offers a wide selection of passive models as well as some active versions with an integrated amplifier.

ACT Version
with integrated amplifier



Features:

- Solid enclosure from MDF wood
- Logo embroidery
- Flow optimized bass tunnel (ventilation)
- Push terminal
- Stable IMPP cone
- U-shape rubber surround
- High power copper voice coil
- Audiophile PC spider
- Woven-in lead wires
- Resonance free steel basket
- 3D dustcap logo
- Plastic injection gasket with logo

ACT Models:

- Powerful active subwoofer
- Class AB MOSFET amplifier
- Adjustable bass boost
- Phase shift option (phase switch)
- Low pass filter (30 - 120 Hz)
- High level input with auto-on function
- Remote control connector*
- *Remote control available separately



GZTA Bassremote
Optional Bassremote for ACT models

Model specifications

GZIB 200XBR

High quality vented subwoofer enclosure
Subwoofer GZIW 250X-II
150 WRMS / 4 Ω



GZIB 200XBR-ACT

High quality vented active subwoofer
100 WRMS / 200 WMAX

GZIB 250XBR

High quality vented subwoofer enclosure
Subwoofer GZIW 250X-II
250 WRMS / 4 Ω



GZIB 250XBR-ACT

High quality vented active subwoofer
130 WRMS / 250 WMAX

GZIB 300XBR

High quality vented subwoofer enclosure
Subwoofer GZIW 300X-II
350 WRMS / 4 Ω



GZIB 300XBR-ACT

High quality vented active subwoofer
150 WRMS / 300 WMAX

GZIB 2.300XBR

High quality vented subwoofer enclosure
700 WRMS / 2x2 Ω



Model specifications

General information

GZIB 3000XSPL
 High quality vented SPL subwoofer
 Subwoofer GZIW 12SPL
 500 WRMS / 1000 WSPL / 2x2 Ω



GZIB 2.3000XSPL
 High quality vented SPL subwoofer
 2x Subwoofer GZIW 12SPL
 1000 WRMS / 2000 WSPL / 4x2 Ω



Satisfying the demand for high level sound pressure, GROUND ZERO offers the a single and a double 12" SPL subwoofer enclosure.

Features:

- Solid enclosure from MDF wood
- Logo embroidery
- Flow optimized bass tunnel (ventilation)
- Push terminal
- High power SPL subwoofer
- Klippel® optimized
- Reinforced paper cone
- 2.5" copper round wire voice coil
- High-Roll sandwich surround
- Progressive 2-layer spider
- Speaker protection bars

IRIDIUM Bass Kit

Model Specifications

Features

GZ BASS KIT 12.300
 Powerful 30 cm / 12" bass kit
 2 Channel class AB amplifier

GZ BASS KIT 12.300 incl. cable
 Powerful 30 cm / 12" bass kit
 2 Channel class AB amplifier
 Including cable kit

- Powerful 30 cm / 12" bass kit
- Loaded subwoofer enclosure
- 37 Liter / 1.31 ft³
- Efficient front bass tunnel
- 2 Channel class AB amplifier
- Output power 300W max
- Bass boost
- Variable lowpass filter
- High-level input with auto-on function





The experience of a real concert atmosphere or club feeling needs professional high SPL levels to be achieved. This however, requires very special and powerful speakers as well as amplifiers. GROUND ZERO's development department doesn't make any compromise, whenever the purpose of the product is that clear. Because of this, a COMPETITION product is the right choice for demanding customers with high SPL level expectations.



Check our webpage
for more details and 360° view!

Model specifications

General information

GZCA 20.0SPL-M1
 1-channel competition SPL amplifier
 1x 12000/20000 W RMS @ 2 / 1 Ω
 Freq. response 10 – 500 Hz

The new line of class D competition amplifiers offers a huge amount of output power for any kind of open show or SPL application. At the top end, the COMPETITION line includes one of the most powerful amplifiers in the world – delivering the unbelievable power of 35.000 Watts RMS!



GZCA 20.0SPL-M1

Features:

- 1 Ω stable subwoofer amplifier
- Power status, clipping and protection LED
- Up to 12 dB adjustable bass boost
- Adjustable high pass filter
- Adjustable low pass filter
- 1x Mono RCA input
- 1x Mono RCA output

GZCA 35.0SPL-M1
 1-channel competition SPL amplifier
 1x 35000 W RMS @ 1 Ω
 Freq. response 5 – 1000 Hz

PURE COMPETITION



GZCA 35.0SPL-M1

- Pure competition amplifier
- Link mode option

COMPETITION Mono SPL amplifiers

General information

Each of the new full range class D amplifiers offers a huge amount of output power for any kind of open show or SPL application.

M1 / M2 - What's the difference?

M1 - Made for 1 Ω operation

The M1 amplifiers shown on this page have been developed for maximum output power @ 1 Ω load.

M2 - Made for 2 Ω operation

The M2 amplifiers shown on this page have been developed for maximum output power @ 2 Ω load.

Model specifications

GZCA 1.5SPL

1-channel competition full range SPL amplifier
Freq. response 10 – 20000 Hz
Model M1: 1x 825/1500 W RMS @ 2 / 1 Ω
Model M2: 1x 825/1500 W RMS @ 4 / 2 Ω



GZCA 3.0SPL

1-channel competition full range SPL amplifier
Freq. response 10 – 20000 Hz
Model M1: 1x 1800/3400 W RMS @ 2 / 1 Ω
Model M2: 1x 1800/3400 W RMS @ 4 / 2 Ω



GZCA 5.0SPL

1-channel competition wide range SPL amplifier
Freq. response 10 – 15000 Hz
Model M1: 1x 2800/5600 W RMS @ 2 / 1 Ω
Model M2: 1x 2800/5600 W RMS @ 4 / 2 Ω



GZCA 8.0SPL

1-channel competition wide range SPL amplifier
Freq. response 10 – 15000 Hz
Model M1: 1x 4480/8960 W RMS @ 2 / 1 Ω
Model M2: 1x 4480/8960 W RMS @ 4 / 2 Ω



GZCA 12.0SPL

1-channel competition wide range SPL amplifier
Freq. response 10 – 15000 Hz
Model M1: 1x 9000/13700 W RMS @ 2 / 1 Ω
Model M2: 1x 9000/13700 W RMS @ 4 / 2 Ω



COMPETITION 2 Channel SPL amplifiers

General information

Apart from the mono amplifiers, GROUND ZERO offers two full range stereo models with an incredibly high output power.

D1 / D2 - What's the difference?

D1 - Made for 1 Ω operation

The D1 amplifiers shown on this page have been developed for maximum output power @ 1 Ω load per channel.

D2 - Made for 2 Ω operation

The D2 amplifiers shown on this page have been developed for maximum output power @ 2 Ω load per channel.

Model specifications

GZCA 750.2

2-channel competition full range SPL amplifier
Freq. response 15 – 20000 Hz
Model D1: 2x 400/750 W RMS @ 2 / 1 Ω
Model D2: 2x 400/750 W RMS @ 4 / 2 Ω



GZCA 1500.2

2-channel competition full range SPL amplifier
Freq. response 11 – 20000 Hz
Model D1: 2x 900/1500 W RMS @ 2 / 1 Ω
Model D2: 2x 900/1500 W RMS @ 4 / 2 Ω



Model specifications

General information



GZCC 165.2SQL
 High power 2-way SQL speaker system
 160 WRMS / 300 WSPL
 Freq. response 50 Hz – 22 kHz
 Components:
 GZCK 165SPL
 GZCT 25SQL

For passive applications, GROUND ZERO offers a 165 mm and a 200 mm 2-way component speaker system. Each system contains a crossover with an option to expand the set by another pair of kick woofers for even more fun and SPL.

Features:

- High power passive speaker system
- High power crossover
- Double woofer connecting option
- Speaker grill
- SQL tweeter



GZCC 200.2SQL
 High power 2-way SQL speaker system
 200 WRMS / 380 WSPL
 Freq. response 50 Hz – 22 kHz
 Components:
 GZCK 200SPL
 GZCT 25SQL

COMPETITION Coaxial speakers

Model specifications

General information



GZCF 165COAX
 High power 2-way coaxial speaker
 125 WRMS / 200 WMAX
 Freq. response 180 Hz – 25 kHz

Apart from the tweeters and midrange drivers, the COMETITION line includes some high-tech full range speakers for extremely loud applications on highest sound quality level.

Features:

- High power coaxial speakers
- Reinforced paper cone
- Compression tweeter
- 6 dB / oct. crossover
- Speaker grill



GZCF 200COAX
 High power 2-way coaxial speaker
 150 WRMS / 250 WMAX
 Freq. response 150 Hz – 25 kHz

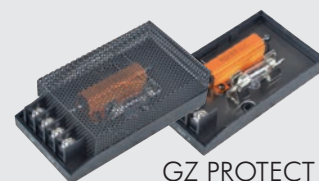

GZ PROTECT
 High quality speaker protection
 Powerhandling 150 W / min. impedance load 2 Ω

COMPETITION Coaxial SPL speaker

Model specifications

General information



GZCF 7104XSPL
 High power 4-way SPL coaxial speaker
 220 WRMS / 300 WMAX
 Freq. response 35 Hz – 25 kHz

The competition line includes a 4-way 7" x 10" SPL coaxial system for customers with highest demands on sound quality and sound pressure level.

General information

For high-frequency and mid-range reproduction, the COMPETITION series offers a variety of high-efficient far-field compression tweeters and various midrange speakers. The latter can be used in free-air applications as well as in horn or bass reflex systems.

Model specifications

GZCT 25SQL
25 mm / 1" horn SQ tweeter
100 WRMS / 150 WMAX
3 – 22 kHz / SPL 93 dB



GZCT 19N-PROX B / S
High-end compression tweeter
30 WRMS / 100 WMAX
3 – 22 kHz / SPL 109 dB



GZCT 3500X-B / S
High power compression tweeter
30 WRMS / 100 WMAX
3 – 25 kHz / SPL 99 dB



GZCT 0500X
High power compression tweeter
30 WRMS / 100 WMAX
4 – 25 kHz / SPL 102 dB



GZCT 500IV-B
High power compression tweeter
30 WRMS / 100 WMAX
4 – 25 kHz / SPL 102 dB



GZCT 1000X
High power compression tweeter
30 WRMS / 100 WMAX
5 – 20 kHz / SPL 105 dB



GZCT 3000X
High power compression tweeter
40 WRMS / 120 WMAX
4 – 25 kHz / SPL 105 dB



GZCT 4000X
High power compression tweeter
50 WRMS / 140 WMAX
2.5 – 20 kHz / SPL 103 dB



For each line of COMPETITION drivers, GROUND ZERO offers a matching subwoofer completing a custom speaker setup.

GZCT 2100X-B
High power compression tweeter
30 WRMS / 100 WMAX
3 – 25 kHz / SPL 99 dB



GZCT 5000SPL / -B
High power compression tweeter
70 WRMS / 180 WMAX
2.5 – 20 kHz / SPL 108 dB



GZCW 12.1200-PRO
High-end SPL woofer
800 WRMS / 1200 WMAX
60 – 2000 Hz / SPL 95 dB
100 mm / 2" copper voice coil



GZCW 12-75SPL
High power SPL woofer
400 WRMS / 800 WMAX
40 – 3000 Hz / SPL 96 dB
75 mm / 3" voice coil



GZCW 12-50
High power woofer
300 WRMS / 600 WMAX
50 – 3000 Hz / SPL 96 dB
50 mm / 2" voice coil



General information

The COMPETITION PRO line marks the very top level of electrically and mechanically possible power handling, nowadays. These drivers have been designed especially for long distance open show and demonstration performances at very high SPL level.

GZCM 6.5N-PRO
 High end 165 mm / 6.5" midrange
 200 WRMS / 400 WMAX
 150 – 12000 Hz / SPL 96 dB
 Neodymium magnet



GZCM 8.0N-PRO
 High end 200 mm / 8" midrange
 300 WRMS / 500 WMAX
 130 – 10000 Hz / SPL 98 dB
 Neodymium magnet



GZCM 6.5SPL
 High power SPL midrange
 100 WRMS / 300 WMAX
 250 – 10000 Hz / SPL 94 dB



GZCM 8.0SPL
 High power SPL midrange
 150 WRMS / 450 WMAX
 170 – 10000 Hz / SPL 95 dB



GZCM 10.0SPL
 High power SPL midrange
 200 WRMS / 500 WMAX
 150 – 10000 Hz / SPL 96 dB



GZCK 165SPL
 High power SPL midwoofer
 100 WRMS / 250 WMAX
 50 – 4000 Hz / SPL 93 dB



GZCK 200SPL
 High power SPL midwoofer
 150 WRMS / 300 WMAX
 50 – 6000 Hz / SPL 93 dB



GZCK 250SPL
 High power SPL midwoofer
 200 WRMS / 400 WMAX
 50 – 6000 Hz / SPL 94 dB



GZCM 6-4PPX
 High power midrange
 150 WRMS / 400 WMAX
 150 – 10000 Hz / SPL 95 dB



GZCM 8-4PPX
 High power midrange
 200 WRMS / 500 WMAX
 150 – 10000 Hz / SPL 96 dB



GZCM 10-4PPX
 High power midrange
 300 WRMS / 600 WMAX
 120 – 5000 Hz / SPL 96 dB



GZCM 6-4FX
 High power flat midrange
 100 WRMS / 300 WMAX
 200 – 5000 Hz / SPL 94 dB



GZCM 8-4FX
 High power flat midrange
 100 WRMS / 400 WMAX
 150 – 4000 Hz / SPL 94 dB



GZCM 10-4FX
 High power flat midrange
 200 WRMS / 500 WMAX
 120 – 5000 Hz / SPL 96 dB





The in-car environment offers adverse conditions and installation positions for speakers. However, inaccurate audio reproduction can be corrected using digital technologies. For this purpose, the GROUND ZERO DSP product line-up contains some multi-channel DSP units with a variety of connection options for OEM or aftermarket systems. The adjustment can be done in real time using the included PC software or even via APP. These features are available for some amplifiers with integrated DSP, as well.



Check our webpage
for more details and 360° view!

Model specifications

GZDSP 6-8X PRO
High quality 6 to 8 channel DSP
6 x RCA input / 6 x high-level input



General information

The advantage of the DSP technology is available as a stand-alone processor unit ready to be added to every sound system including all important features like time alignment, equalizing and crossover adjustment.

Features:

- 8-channel digital signal processor
- High-level and line (RCA) input
- Realtime setting via PC software
- 32-bit Cirrus Logic processor
- Windows GUI software
- 31-band equalizer for each channel
- Time delay
- Variable crossover
- Phase correction
- Automatic turn-on function (high-level in)
- Optical & coaxial digital input
- 24-bit / 192 kHz

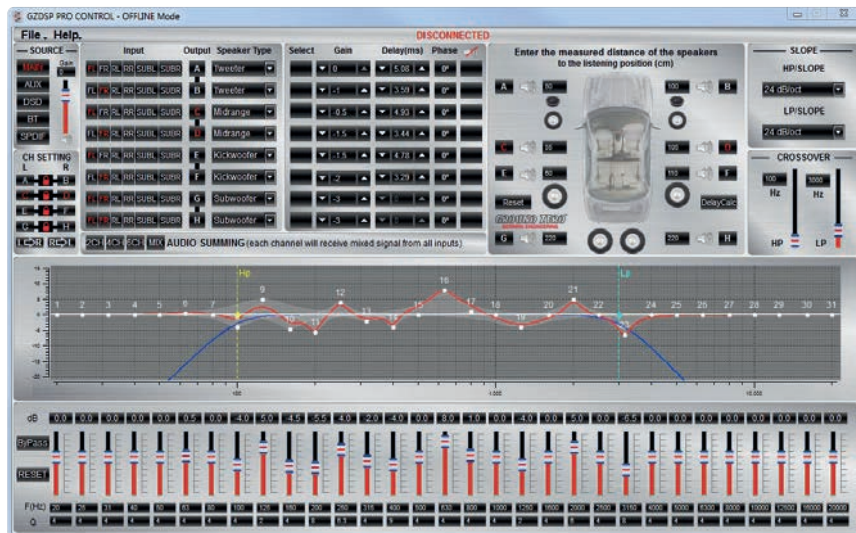

GZCS HLC-2.6 (no picture)
Adapter for car specific harness to be used with GZDSP PRO units compatible with
GZCS 4.0BMW-Connect
GZCS MB-Connect



GZDSP BT-BOX
Interface for wireless music streaming

Compatible with:
GZDSP 6-8X and 6-8X PRO,
GZDSP 4.80AMP, GZDSP 4.80A-PRO, GZDSP 4.60ISO
Including connection wire
Features:
Interface for wireless music streaming
SBC coded transmission
Max. transmission rate 44.1 kHz / 16-bit
Transmission speed 328 kb/s
Max. range 10 m



GZDSP REMOTE PRO
Wired remote control for GZDSP PRO units

This remote control enables the user to adjust GZDSP PRO units easily from the drivers or passengers seat.

Remote options:
Source selection
Main level
Subwoofer level
Preset selection
Mute function
Including connection wire



Scan code for latest software updates!

General information

The GZDSP 4.60ISO space saving amplifier combines the whole feature range of a DSP with the simple integration method of a 4-channel ISO amplifier offering another four processed pre-out channels to expand the setup with further amps if required. The new GZDSP 4.80A-PRO is a powerful and high efficient 4-channel amplifier offering the features of the GZDSP PRO unit.

Features:

- 8-channel digital signal processor
- High-level input
- 6-channel RCA input (GZDSP 4.80A-PRO)
- Realtime setting via PC software
- 32-bit Cirrus Logic processor
- Windows GUI software
- 31-band equalizer for each channel
- Time delay
- Variable crossover
- Phase correction
- Automatic turn-on function (high-level input)
- Optical digital input
- Coaxial digital input (GZDSP 4.80A-PRO)
- AUX input

Available accessories:



GZDSP BT-BOX
Interface for wireless music streaming for GZDSP amplifiers



GZDSP REMOTE
Wired remote control for GZDSP units (not for PRO units)



GZDSP REMOTE PRO
Wired remote control for GZDSP PRO units

Model specifications

GZDSP 4.60ISO
High quality 4-channel ISO amplifier
Integrated 8-channel DSP
4x 40 / 4x 60 @ 4 / 2 Ω
Remote control GZDSP REMOTE available optionally



GZCS HLC-1.12
Adapter for car specific harness to be used with GZDSP units (not for PRO units) compatible with GZCS 4.0 BMW-Connect GZCS MB-Connect

GZDSP 4.80A-PRO
High quality 4-channel class D amplifier
Integrated 8-channel DSP
4x 90 / 150 @ 4 / 2 Ω
2x 350 W @ 4 Ω (bridged max)
Remote control GZDSP REMOTE PRO available optionally



GZCS HLC-2.6 (no picture)
Adapter for car specific harness to be used with GZDSP PRO units compatible with GZCS 4.0BMW-Connect GZCS MB-Connect

Model specifications

GZDSP 4-8X
 High quality 4 to 8 channel DSP
 4x RCA input / 4x high-level input



General information

The advantage of the DSP technology is available as a stand-alone processor unit ready to be added to every sound system including all important features like time alignment, equalizing and crossover adjustment.

Features:

- 8-channel digital signal processor
- 4-channel high-level input
- 4-channel line (RCA) input
- Realtime setting via PC software or APP
- (requires optional adapter)
- 2x 28-bit Analog Devices signal processor
- Windows GUI software
- 10-band equalizer for each channel
- Time delay
- Variable crossover
- Phase correction
- Automatic turn-on function
- Wired remote control

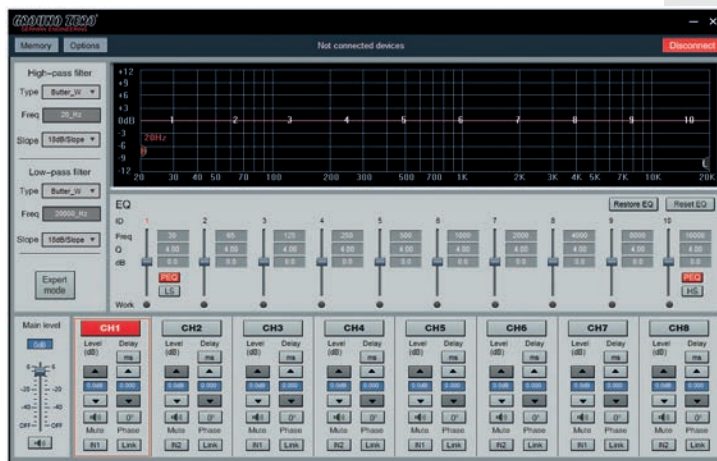

Scan code for latest software updates!

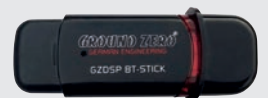

GZDSP BT-STICK
 USB interface for wireless music streaming and app control

DSP - Accessories

Model specifications

GZDSP BT-STICK
 USB interface
 for wireless music streaming
 and app control



General information

USB interface for wireless music streaming
 Compatible with GZDSP 4-8X
 Control app available for iOS and Android

Features:

- USB Stick (BT class II)
- Transmission frequency 2.4 GHz
- Max. range 10 m



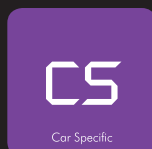

Most OEM speaker systems cannot completely satisfy the expectations of sophisticated customers. Especially the basic equipment leaves a lot of space for improvements of dynamics and sound quality. Installing car specific aftermarket speakers is a simple way to enhance the audio system. GROUND ZERO's line of CAR SPECIFIC solutions consists of various components designed for upgrading the OEM audio systems of modern cars easily.



Will it fit?
Scan code for compatibility list!

Model specifications

General information

GZCS 100MB
 Car specific 2-way system
 50 WRMS / 100 WMAX
 Freq. response 70 – 30000 Hz

In order to upgrade the basic version of the factory-installed audio system of a Mercedes-Benz car, a specially tailored speaker system is available for the original slots.

Features:

- Car specific 2-way speaker system
- 100 mm / 4" midwoofer with alu cone
- Car specific aluminum cast basket
- Rubber surround
- Neodymium motor
- 25 mm / 1" silk dome tweeter
- 12 dB/oct in-line crossover
- Car specific connectors
- Compatible with Mercedes-Benz according to compatibility chart (online)



CAR SPECIFIC Subwoofer - Mercedes-Benz

Model specifications

General information

GZCS 200MB-LHD
 Car specific subwoofer
 50 WRMS / 90 WMAX
 Freq. response 40 – 2000 Hz

Additionally, the OEM woofer can be replaced. Check the compatibility chart on the GROUND ZERO web page for the appropriate product for your car model.

Features:

- Compatible with Mercedes-Benz according to compatibility chart (online)

Available versions:

- GZCS 200MBL-LHD:
Driver side / left hand drive cars
- GZCS 200MBR-LHD:
Passenger side / left hand drive cars



GZCS MB-CONNECT
 Car specific wiring harness for Mercedes-Benz

CAR SPECIFIC Coaxial speakers - Mercedes-Benz

Model specifications

General information

GZCS 12CX
 Car specific 2-way coaxial speaker
 60 WRMS / 100 WMAX
 Freq. Response 75 – 20000 Hz

In order to upgrade the sound system of a Mercedes-Benz W124, GROUND ZERO offers a specific speaker system matching the OEM installation positions.



General information

In order to upgrade the basic sound system of a BMW or MINI, GROUND ZERO offers speaker systems matching the OEM installation positions. Due to the specific design, no change to the original wiring is necessary. Check the compatibility chart on the GROUND ZERO web page for the appropriate product for your car model.

Features:

- Car specific 2-way speaker system
- Pressed paper cone
- Rubber surround
- Compound basket
- High-efficient 3 Ω impedance
- 25 mm / 1" titanium dome tweeter
- In-line high-pass crossover (Tweeter)
- Car specific mounting frame
- Car specific connection
- Freq. response 100 – 26000 Hz



Made in Germany



Rear shelf mounting bracket and tweeter high-pass crossover included!

Model specifications

GZCS 100BMW-A

Car specific 2-way speaker system
50 WRMS / 100 WMAX
compatible with BMW / MINI
(according to compatibility chart)



GZCS 100BMW-B

Car specific 2-way speaker system
50 WRMS / 100 WMAX
compatible with BMW / MINI
(according to compatibility chart)



GZCS 100BMW-C

Car specific 2-way speaker system
50 WRMS / 100 WMAX
Compatible with BMW / MINI
(according to compatibility chart)



GZCS 100BMW-D

Car specific 2-way speaker system
50 WRMS / 100 WMAX
compatible with BMW / MINI
(according to compatibility chart)



CAR SPECIFIC Speakers - MINI

Model specifications

GZCS 100MINI

Car specific 2-way speaker system
50 WRMS / 100 WMAX
suitable for:
MINI* F54 / F55 / F56 / F57
(*with MINI Basic Sound System)
No additional A-pillar parts needed



Will it fit?
Scan code for compatibility list!

Model specifications

General information



GZCS 100BMW-SA
Car specific 2-way speaker system
50 WRMS / 100 WMAX
compatible with BMW / MINI
(according to compatibility chart)



GZCS 100BMW-SB
Car specific 2-way speaker system
50 WRMS / 100 WMAX
compatible with BMW / MINI
(according to compatibility chart)



GZCS 100BMW-SC
Car specific 2-way speaker system
50 WRMS / 100 WMAX
Compatible with BMW / MINI
(according to compatibility chart)



GZCS 100BMW-SD
Car specific 2-way speaker system
50 WRMS / 100 WMAX
compatible with BMW / MINI
(according to compatibility chart)

GROUND ZERO offers the BMW specific speakers with a high quality silk dome tweeter, as well.

Features:

- Car specific 2-way speaker system
- Pressed paper cone
- Rubber surround
- Compound basket
- High-efficient 3 Ω impedance
- 25 mm / 1" silk dome tweeter
- In-line high-pass crossover (Tweeter)
- In-line high-pass crossover (Midrange)
- Car specific mounting frame
- Car specific connection
- Freq. response 100 – 25000 Hz



Made in Germany



Rear shelf mounting bracket, midrange and tweeter high-pass crossover included!

CAR SPECIFIC Subwoofer - BMW / MINI

Model specifications

General information



GZCS 200BMW-SW
Car specific underseat woofer
100 WRMS / 160 WMAX
Suitable for:
BMW E6.. / E7.. / E8.. / E9
BMW F- and G-Models
MINI F-Models

Available accessory:
GZCS 4.0BMW-CONNECT
Car specific wiring harness



Additionally to the full range component speaker system, GROUND ZERO offers a matching subwoofer for BMW and MINI.

Features:

- Underseat subwoofer (1 pair)
- 200 mm / 8"
- Neodymium motor
- 50 mm / 2" copper voice coil
- High efficient 2 Ω impedance
- Freq. Response 35 – 250 Hz

General information

GROUND ZERO offers a specific component speaker system for VW / Skoda / Seat matching the OEM installation positions.

Features:

- Car specific 2-way speaker system
- High-efficient 3 Ω impedance
- Aluminum cone
- Resonance free steel basket
- 25 mm / 1" titanium dome tweeter
- Car specific connectors
- Tweeter in-line high-pass crossover
- Plug'n'Play accessories included

Model specifications

GZCS 165VW

Car specific 2-way speaker system
120 RMS / 190 WMAX
Freq. response 35 – 26000 Hz
compatible with VW / Skoda / Seat
(according to compatibility chart)



CAR SPECIFIC Speakers - Volkswagen T6

General information

The GZCS 200VW-T6 has been developed especially for the request of demanding customers driving a VW T6 model.

Features:

- Car specific 2-way speaker system
- High-efficient 3 Ω impedance
- Pressed paper cone
- Fiber reinforced polyamide basket
- 28 mm / 1.1" silk dome tweeter
- Car specific connectors
- Tweeter in-line high-pass crossover
- Plug'n'Play solution

Model specifications

GZCS 200VW-T6

Car specific 2-way speaker system
100 RMS / 160 WMAX
Freq. response 40 – 25000 Hz
compatible with Volkswagen T6



CAR SPECIFIC Speakers

General information

GROUND ZERO offers car specific coaxial speakers matching the OEM installation positions of various vehicles.

Features:

- Car specific 2-way coaxial speaker
- Coated paper cone
- Mylar Tweeter

Model specifications

GZCS 46CX

Car specific 2-way coaxial speaker system
70 WRMS / 110 WMAX
80 – 20000 Hz
Suitable for various vehicles



GZCS 8.7CX

Car specific 2-way coaxial speaker system
50 WRMS / 90 WMAX
Freq. response 100 – 20000 Hz
Suitable for various vehicles



Will it fit?
Scan code for compatibility list!

Model specifications

GZCS 10SUB
 Flat spare wheel subwoofer
 Double voice coil 2x 2 Ω
 Power handling 300 W



GZCS 10SUB-ACT
 Flat spare wheel active subwoofer
 Class AB amplifier 300 WMAX
 High-Level input with auto-on



General information

Especially the bass response of a basic OEM speaker system leaves many wishes unfulfilled. For some models, GROUND ZERO offers a simple solution that significantly increases the low frequency response. Using the spare wheel compartment, the trunk space remains untouched. This subwoofer solution is available as an active version with integrated amplifier or as a passive version.

Passive model features:

- High quality spare wheel recess subwoofer
- Perfect solution for the spare wheel recess
- No cut-out in the trunk floor panel
- Efficient downfiring technology
- Solid sealed MDF enclosure
- High power 25 cm / 10" woofer
- Reinforced paper cone
- Klippel® optimized

Active model additional features:

- Class AB MOSFET amplifier
- Adjustable bass boost
- Phase shift option (phase switch)
- Low pass filter (30 – 120 Hz)
- High level input with auto-on function
- Remote control connector (GZTA Bassremote available separately)



GZTA Bassremote
 Optional Bassremote for ACT models

((NO VIBRATION - JUST SOUND))



Stop
Vibration



Higher Acoustic
Performances



Insulate
Heat

Model specifications

GZDM DOORKIT

- Damping kit for 2 doors
- Self adhesive high efficient damping material

Package content:

- 8 sheets GZDM 3750AB-SILVER
- Polymer damping material based on butyl rubber with layer of alminum
- 4 sheets GZDF 1500SA
- High efficient sound absorbing polyurethane foam
- 2 sheets Waterproof high density noise damping polyethylene foam
- Size per sheet: 375 x 500 mm / 14.76" x 19.69"

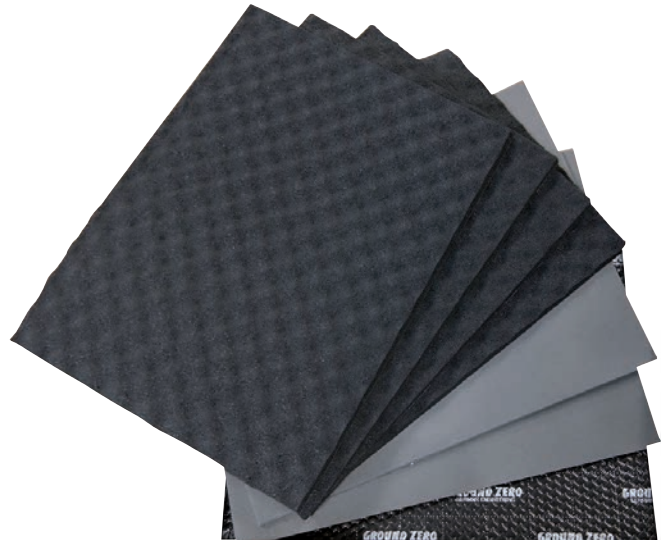

GZDF 1500SA

- Self adhesive lightweight single layer damping material
- High efficient viscous-elastic sound absorbing polyurethane foam
- Application inside of the passenger's compartment and on the backside of the door trims
- Heat insulating and vibration damping when compressed
- Noise absorbing: -85%
- Total thickness: 15 mm / 0.59"
- Size per sheet: 500 x 375 mm / 14.76" x 19.69"
- Package contents: 8 sheets



GZDR 1000

Heavy duty damping roller



Model specifications



GZDM 3750AB-GOLD

- Self adhesive high efficient single layer damping material
- One layer of polymer based butyl rubber
- Aluminum foil as outer surface
- Application on body parts, doors and panels
- High mechanical loss factor
- Very flexible and waterproof
- Total thickness: 2,2 mm / 0.087"
- Size per sheet: 750 mm x 500 mm / 29.53" x 19.69"
- Package content: 10 sheets



GZDM 3750AB-SILVER

- Self adhesive lightweight single layer damping material
- One layer of polymer based butyl rubber
- Aluminum foil as outer surface
- Application on body parts, doors and panels
- High mechanical loss factor
- Very flexible and waterproof
- Total thickness: 1,7 mm / 0.067"
- Size per sheet: 750 mm x 500 mm / 29.53" x 19.69"
- Package content: 10 sheets



GZDM 1900ML-GOLD

- Self adhesive high efficient multi layer damping material
- One layer of bitumen mastic
- One layer of polymer based butyl rubber
- Aluminum foil as outer surface
- Application on body parts, doors and panels
- Very high mechanical loss factor
- Total thickness: 4,2 mm / 0.165"
- Size per sheet: 375 mm x 500 mm / 14.76" x 19.69"
- Package content: 10 sheets



GZDA 1200AL-GOLD

- Massive aluminum foil to cut individually and to seal openings inside the doors for acoustical reasons and to avoid the intrusion of moisture into the vehicle's compartment. Self-adhesive, temperature and water resistant, not flammable
- Total thickness 300 μ m / 0.012"
- Dimensions (plate) 375 x 500 mm / 14.76" x 19.69"
- Package content 6 sheets



GZDM 250AL-BassBoost

- Self-adhesive multilayer, non-inflammable damping material with a specifically molded aluminum surface reducing the reflection of sound waves and pressure when installed directly on the backside of a dynamical speaker
- Total thickness 15 mm +/- 4 mm
- Dimensions (sheet) 250 x 183 mm / 9.84" x 7.20"
- Package content 2 sheets (for 2 doors)



GZDM 1900MC-GOLD

- Self adhesive multi component damping material
- One layer of viscous elastic polyurethane foam
- One layer of polymer based butyl rubber
- Aluminum foil as substrate
- Application on body parts, doors, panels and coverings.
- Noise absorption: -85%
- Total thickness: 7 mm / 0.28"
- Size per sheet: 375 mm x 500 mm / 14.76" x 19.69"
- Package content: 10 sheets

ACCESSORIES - OFC speaker cables

General information

In order to transport the music signal as lossless as possible from the amplifier to the loudspeaker, a high-quality and sufficiently dimensioned cable is required. GROUND ZERO offers highly flexible CCA and OFC cable in many common diameters.

Features:

- High quality OFC copper speaker cable
- Black and yellow color isolation
- Highly felxible
- Wooden spool

Model specifications



GZSC 1.5X2 OFC
2x 1.50 mm²
100 m / 328.08 ft spool



GZSC 2.5X2 OFC
2x 2.50 mm²
100 m / 328.08 ft spool



GZSC 4.0X2 OFC
2x 4.00 mm²
75 m / 246.06 ft spool



GZSC 6.0X2 OFC
2x 6.00 mm²
50 m / 164.04 ft spool



GZSC 10.0X2 OFC
2x 10.00 mm²
50 m / 164.04 ft spool

ACCESSORIES - CCA speaker cables

General information

In order to transport the music signal as lossless as possible from the amplifier to the loudspeaker, a high-quality and sufficiently dimensioned cable is required. GROUND ZERO offers highly flexible CCA and OFC cable in many common diameters.

Features:

- High quality CCA speaker cable
- Brown translucent isolation
- Highly felxible
- Plastic spool

Model specifications



GZSC 2-0.75
2x 0.75 mm² - 200 m / 656.17 ft spool



GZSC 2-1.50
2x 1.50 mm² - 200 m / 656.17 ft spool



GZSC 2-2.50
2x 2.50 mm² - 200 m / 656.17 ft spool



GZSC 2-4.00
2x 4.00 mm² - 100 m / 328.08 ft spool

Model specifications



GZPC 10B/R
10 mm² / 7 AWG - 50 m / 164.04 ft spool



GZPC 20B/R
20 mm² / 4 AWG - 50 m / 164.04 ft spool



GZPC 35B/R
35 mm² / 2 AWG - 30 m / 98.43 ft spool



GZPC 50B/R
50 mm² / 0 AWG - 20 m / 65.62 ft spool

General information

Only an adequately dimensioned and needs-based power wiring ensures that the best performance and highest possible power will be delivered by the installed components. For this reason, GROUND ZERO offers highly flexible CCA power cables in all common diameters on roles.

Features:

- High quality CCA power wire
- Black/Red translucent isolation
- Highly flexible
- Plastic spool

ACCESSORIES - Power kits

Model specifications



GZPK 50X
50 mm² / 0 AWG power kit
Triple shielded RCA cable
ANL fuseholder incl. 300 A fuse



GZPK 35X
35 mm² / 2 AWG power kit
Triple shielded RCA cable
ANL fuseholder incl. 200 A fuse



GZPK 20X
20 mm² / 4 AWG power kit
Triple shielded RCA cable
Mini ANL fuseholder incl. 80 A fuse



GZPK 10X
10 mm² / 7 AWG power kit
Triple shielded RCA cable
Mini ANL fuseholder incl. 60 A fuse



GZPK 10XLC
10 mm² / 7 AWG power kit
Twisted RCA cable
1.5 m / 4.92 ft 2.5 mm² / 13 AWG speaker cable
Mini ANL fuseholder incl. 60 A fuse

General information

- High quality amplifier connection kits
- Flexible CCA wire with copper coating
- Red power wire (5.2 m / 17.06 ft)
- Black ground wire (0.8 m / 2.62 ft)
- Shielded RCA cable (5m / 16.4 ft)
- Including accessories and connectors



ACCESSORIES - Triple shielded RCA cables

General information

In order to transmit the music signal unaffectedly and as lossless as possible from the signal source to the amplifier, it requires a high-quality and well-shielded RCA cable. GROUND ZERO offers a number of different models in common lengths.

Features:

- Triple shielded, twisted RCA cable
- Gold plated brass RCA connectors
- Black & yellow snake skin
- Blister packaging

Model specifications

GZCC X-TP

Available versions:

- GZCC 0.57X-TP: 0.57 m / 1.87 ft
- GZCC 1.14X-TP: 1.14 m / 3.74 ft
- GZCC 3.14X-TP: 3.14 m / 10.3 ft
- GZCC 5.49X-TP: 5.49 m / 18.01 ft



ACCESSORIES - RCA cables

General information

Universal shielded or twisted RCA signal cables, available in different sizes.

Model specifications

GZCC 1.3X

High quality RCA cable
1 m / 3.28 ft triple shielded
Including remote wire



GZCC 5.3X

High quality RCA cable
5 m / 16.4 ft triple shielded
Including remote wire



GZCC 5.1XLC

High quality twisted RCA cable
5 m / 16.4 ft single shielded



GZCY 30X

High quality Y-adapter
1 x female / 2 x male

ACCESSORIES - Adapter

General information

Car specific wiring harnesses for various vehicles. To be used with the high level input of GZRA MICRO FOUR.

Model specifications

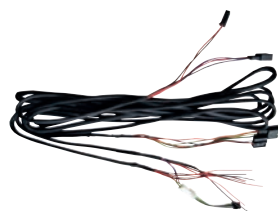

GZCS MB-CONNECT

Car specific wiring harness for Mercedes-Benz



GZCS 4.0BMW-CONNECT

Car specific wiring harness for BMW /MINI

Model specifications

General information

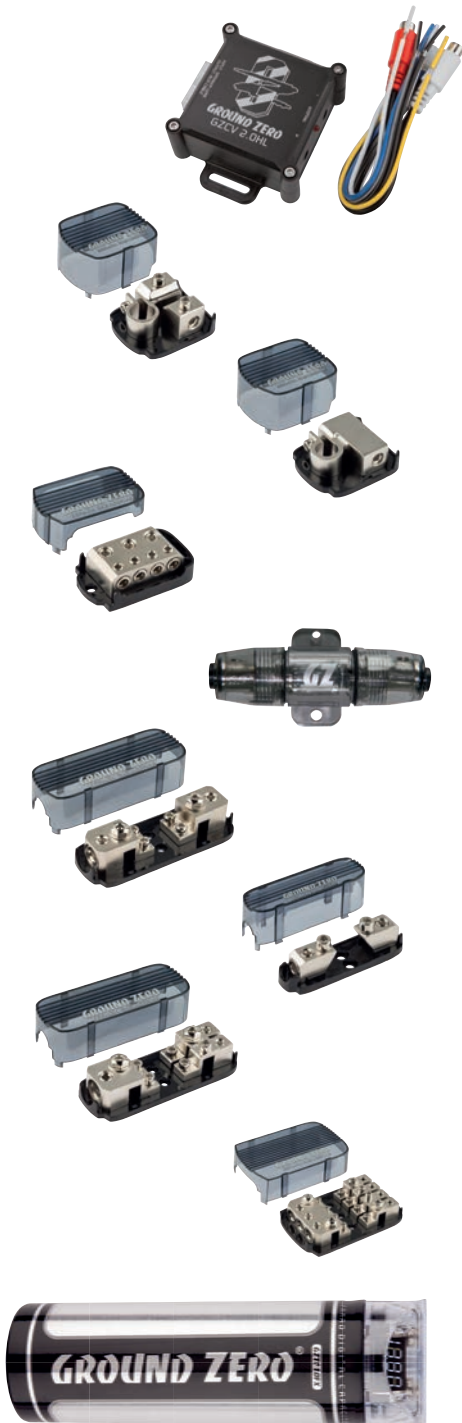

GZCV 2.0HL
Active high to low converter
12 V Remote out

GZBT 2.50MANL-POS
Positive battery terminal w. Mini-ANL fuseholder
1x 50 mm² / 0 AWG unfused
1x 50 mm² / 0 AWG fused

GZBT 2.50NEG
Negative battery terminal
2x 50 mm² / 0 AWG

GZDB 3.50/4.20
Distribution block
3x 50 mm² / 0 AWG
4x 20 mm² / 4 AWG

GZFH 1.20 IL-MANL
In-line Mini-ANL fuseholder
20 mm² / 4 AWG

GZFH 1.20/1.20 MANL
Mini-ANL fuseholder
20 mm² / 4 AWG

GZFH 1.50/1.50 ANL/MANL
ANL / Mini-ANL fuseholder
50 mm² / 0 AWG

GZFH 1.50/2.20 ANL/MANL
ANL / Mini-ANL fuseholder
1x 50 mm² / 0 AWG
2x 20 mm² / 4 AWG

GZFH 3.50/4.20 ANL/MANL
ANL / Mini-ANL fuseholder
3x 50 mm² / 0 AWG
4x 20 mm² / 4 AWG

GZTC 1.0FX
1.0 Farad Power Cap
16 V / 20 V Surge
Voltmeter with white illumination
Including mounting bracket

GROUND ZERO offers a wide range of distribution blocks and fuseholders needed for the installation of audio components in your vehicle. Besides that, further products complete the accessory line.

Blister packaging



FUSES

Model specifications

General information



GZFU ANL
available 100 – 400 Ampere



GZFU MANL
available 40 – 200 Ampere



High quality ANL and MANL fuses from 40 up to 400 Ampere, available in blister or in 10 piece bulk packaging.

General information

Playing music in particularly difficult external conditions such as dirt, dust or sand, cold or heat and moisture or rain requires a specially developed and defying all the aforementioned adversity loudspeaker. GROUND ZERO offers such a model in two color variants. The massive mounting bracket keeps the loudspeakers in place on the ATV or on the boat even during dynamic driving. The integrated variable LED lighting can be controlled by remote control.

Features:

- Water-resistant 2-way marine speaker
- IMPP cone
- Rubber surround
- Rainwater and splash protected
- Salt water resistant
- 25 mm / 1" PEI tweeter
- Sealed ABS enclosure (IPX-5)
- Multicolor LED illumination
- IR remote control for LED illumination
- Mounting accessories included



Model specifications

GZMS 65LED-B / -W

Water-resistant 2-way marine speaker
60 WRMS / 120 WMAX
Freq. response 70 – 22000 Hz
4 Ω impedance

Available colors:

- Black
- White



Model specifications

GZRM 165X
Water-resistant 2-way coaxial speaker
70 WRMS / 120 WMAX
Freq. response 60 – 25000 Hz



General information

Since listening to favorite music isn't limited to cars, GROUND ZERO offers a particular speaker for environments with special requirements to the construction and water resistance. The MARINE series coaxial speaker is available in white finish, suitable for places with high humidity such as bathrooms and pool areas or even for off-shore applications with occasionally appearing direct splashing water such as on outer decks or on leisure boats.

Features:

- 2-way marine coaxial speaker system
- IMPP cone
- Rubber surround
- Rainwater and splash protected
- Salt water resistant
- 13 mm / 0.51" PEI tweeter
- White frame and protection grill



MARINE Accessories

Model specifications

GZWR 10M
Wireless music streaming receiver



General information

Universal wireless music streaming receiver with water-resistant chromed bezel and touch screen display.

Features:

- Wireless music streaming receiver
- LED illumination
- AUX input 3.5 mm jack
- RCA output (1 pair / max. 3 V)
- Remote input/output
- Mobile device player control
- Main level control
- Operation voltage 9-16 Volt

General information

If you would like to enjoy the typical GROUND ZERO sound not only in your vehicle, you may choose one of the two headphones. Both of them delivering a distinctive bass response and the dynamic sound character.



Model specifications

GZHP 10-IE









Powerful in-ear headphone with aluminum housing
 Speaker: 10 mm
 Sensitivity: 98 ± 3 dB at 1 KHz
 Microphone sensitivity: -42 ± 4 dB
 Frequency Response: 20 Hz – 20 kHz
 Impedance: $32 \pm 15\%$ Ω
 Plug Type: 3.5 mm jack
 Cable length: 120 cm / 47"
 Weight: 15 g
 In-line microphone
 Headset function
 Accessories included



GZHP 40-OE

High quality foldable on-ear headphone
 Speaker: 40 mm
 Sensitivity: 100 ± 3 dB at 1 KHz
 Microphone sensitivity: -43 ± 4 dB
 Frequency Response: 20 Hz – 20KHz
 Impedance: $32 \pm 15\%$ Ω
 Max Power: 30 mW
 Plug Type: 3.5 mm
 Cable length: 120 cm / 47"
 Cable: Dual side cable
 Weight: 150 g
 In-Line Mic compatible with
 Apple/Samsung/HTC and more



Technical product information		
	Amplifiers	68
	DSP & Competition amplifiers	69
	Active subwoofers	69
	Subwoofer enclosures	70
	Speaker systems	70
	Coaxial speakers	71
	Kickwoofer / Midwoofer / Midrange / Fullrange speakers	71
	Tweeters	72
	Subwoofers	73

Amplifiers												
Series	Product	Output power @ 4/2/1 Ohm	Bridged max @ 4/2 Ohm (link mode)	LPF	HPF / *Subsonic	BP	Bass-boost	Phase-shift	Remote	Line Out	High-level & auto-on	Dimensions (mm/inch)
GZPA	GZPA Reference 2 Pure	2x 420/750/1150 W	1x 1800/2700 W max									236 x 68 x 590 9.29 x 2.67 x 23.23
	GZPA Reference 4 Pure	4x 150/270/425 W	2x 650/1000 W max									236 x 67,5 x 590 9.29 x 2.66 x 23.23
GZPA	GZPA 2SQ	2x 175/315/500 W	1x 630/1000 W max	✓	✓	✓	✓	✓				222 x 61 x 420 8.74 x 2.40 x 16.54
	GZPA 4SQ	4x 125/225/350 W	2x 450 W & 2x 700 W @ 4 Ohm	✓	✓	✓	✓					222 x 60.5 x 420 8.74 x 2.38 x 16.54
GZNA	GZNA 1.2550DXII	1x 850/1500/2400 W	1x 6200 W max @ 2 Ohm (linkmode)	✓	Subsonic	✓	✓	✓	✓	✓		293 x 67 x 560 11.54 x 2.64 x 22.05
	GZNA 2850XII	2x 430/800/1200 W	1x 2800 W max @ 2 Ohm	✓	✓	✓	✓	✓	✓			293 x 67 x 600 11.54 x 2.64 x 23.62
	GZNA 4330XII	4x 200/350/550 W	2x 1300 W max @ 2 Ohm	✓	✓	✓	✓	✓	✓			293 x 67 x 560 11.54 x 2.64 x 22.05
GZUA	GZUA 2.250SQ-Plus	2x 180/320/500 W	1x 1200 W max @ 2 Ohm	✓	✓	✓	✓	✓	✓	✓		209 x 46 x 360 8.23 x 1.81 x 14.17
	GZUA 4.150SQ-Plus	4x 110/190/- W	2x 460 W max @ 4 Ohm	✓	✓	✓						209 x 46 x 360 8.23 x 1.81 x 14.17
	GZUA 6.200SQ-Plus	4x 110/160/- & 2x 160/280/-	2x 320 W & 1x 560 W max @ 4 Ohm	✓	✓	✓						209 x 46 x 550 8.23 x 1.81 x 21.65
GZHA	GZHA 1.1850DXII	1x 700/1200/1850 W	1x 4800 W max @ 2 Ohm (linkmode)	✓	Subsonic	✓	✓	✓	✓	✓		293 x 67 x 400 11.54 x 2.64 x 15.75
	GZHA 2400XII	2x 270/480/750 W	1x 1800 W max @ 2 Ohm	✓	✓	✓	✓	✓	✓			293 x 67 x 400 11.54 x 2.64 x 15.75
	GZHA 4200XII	4x 140/200/- W	2x 500 W max @ 4 Ohm	✓	✓	✓	✓	✓	✓	✓		293 x 67 x 400 11.54 x 2.64 x 15.75
	GZHA MINI ONE	1x 220/390/630 W	1x 1500 W max @ 2 Ohm (linkmode)	✓	Subsonic	✓	✓	✓	✓	✓	✓	135 x 52 x 210 5.32 x 2.05 x 8.27
	GZHA MINI ONE-K	1x 340/600/1000 W	1x 2300 W max @ 2 Ohm (linkmode)	✓	Subsonic	✓	✓	✓	✓	✓	✓	135 x 52 x 322 5.32 x 2.05 x 12.68
	GZHA MINI TWO	2x 130/230/- W	1x 550 W max @ 4 Ohm	✓	✓	✓		✓	✓	✓	✓	135 x 52 x 210 5.32 x 2.05 x 8.27
	GZHA MINI FOUR	4x 80/130/- W	2x 320 W max @ 4 Ohm	✓	✓	✓		✓			✓	135 x 52 x 210 5.32 x 2.05 x 8.27
GZHA MINI FIVE	4x 75/125/- W & 1x 190/320/500 W	2x 300 W @ 4 Ohm	✓	✓	✓			✓		✓	135 x 52 x 322 5.32 x 2.05 x 12.68	
GZRA	GZRA 1.1650DX	1x 650/1250/1800 W	1x 4600 W max @ 2 Ohm (linkmode)	✓	Subsonic		✓	✓	✓	✓		230 x 53 x 446 9.06 x 2.09 x 17.56
	GZRA 1.2500DX	1x 750/1400/2200 W	1x 6000 W max @ 2 Ohm (linkmode)	✓	Subsonic		✓	✓	✓	✓		230 x 53 x 615 9.06 x 2.09 x 24.21
	GZRA 2255X	2x 150/250/- W	1x 600 W max @ 4 Ohm	✓	✓	✓	✓		✓			230 x 53 x 396 9.06 x 2.09 x 16.34
	GZRA 4230X	4x 140/230/-	2x 550 W max @ 4 Ohm	✓	✓	✓	✓					230 x 53 x 476 9.06 x 2.09 x 18.74
	GZRA MICRO ONE	1x 220/350/- W	1x 400 W max @ 2 Ohm	✓	Subsonic		✓		✓		✓	75 x 44 x 190 2.95 x 1.73 x 7.48
	GZRA MICRO FOUR	4x 60/100/- W	2x 250 W max @ 4 Ohm	✓	✓						✓	75 x 44 x 190 2.95 x 1.73 x 7.48
GZTA	GZTA 1.800DX-II	1x 350/550/850 W	1x 2000 W max @ 2 Ohm (linkmode)	✓	Subsonic	✓	✓	✓	✓	✓		230 x 53 x 365 9.06 x 2.09 x 14.37
	GZTA 1.800DX-II24V	1x 350/550/850 W	1x 2000 W max @ 2 Ohm (linkmode)	✓	Subsonic	✓	✓	✓	✓	✓		230 x 53 x 365 9.06 x 2.09 x 14.37
	GZTA 1.1200DX-II	1x 400/800/1300 W	1x 3000 W max @ 2 Ohm (linkmode)	✓	Subsonic	✓	✓	✓	✓	✓		230 x 53 x 445 9.06 x 2.09 x 17.52
	GZTA 4125X-II	4x 90/130/- W	2x 320 W max @ 4 Ohm	✓	✓	✓	✓					230 x 53 x 396 9.06 x 2.09 x 15.59
	GZTA 4125X-II24V	4x 90/130/- W	2x 320 W max @ 4 Ohm	✓	✓	✓	✓					230 x 53 x 397 9.06 x 2.09 x 15.63
	GZTA 5120X-II	4x 50/70/- W & 1x 180/260/- W	2x 170 W max @ 4 Ohm & 300 W max @ 2 Ohm	✓	✓	✓	✓	✓	✓			230 x 53 x 476 9.06 x 2.09 x 18.74
GZIA	GZIA 1.600HPX-II	1x 230/400/600 W	1x 700 W max @ 1 Ohm	✓			✓		✓		✓	192 x 49 x 332 7.56 x 1.93 x 13.07
	GZIA 1.1000DX-II	1x 350/650/1000 W	1x 1200 W max @ 1 Ohm	✓			✓	✓	✓		✓	192 x 49 x 302 7.56 x 1.93 x 11.89
	GZIA 1.1450DX-II	1x 400/750/1250 W	1x 1450 W max @ 1 Ohm	✓			✓	✓	✓		✓	192 x 49 x 360 7.56 x 1.93 x 14.17
	GZIA 2080HPX-II	2x 60/80/- W	1x 240 W max @ 4 Ohm	✓	✓						✓	192 x 49 x 174 7.56 x 1.93 x 6.85
	GZIA 2130HPX-II	2x 85/130/- W	1x 320 W max @ 4 Ohm	✓	✓				optional		✓	192 x 49 x 214 7.56 x 1.93 x 8.43
	GZIA 2235HPX-II	2x 150/235/- W	1x 540 W max @ 4 Ohm	✓	✓				optional		✓	192 x 49 x 284 7.56 x 1.93 x 11.18
GZIA 4115HPX-II	4x 70/115/- W	2x 250 W max @ 4 Ohm	✓	✓						✓	192 x 49 x 284 7.56 x 1.93 x 11.18	

DSP Amplifiers

Series	Product	Output power @ 4/2/1 Ohm	Bridged max @ 4/2 Ohm	LPF	HPF / *Subsonic	BP	Bass-boost	Phase-shift	Remote	Line Out	High-level & auto-on	Dimensions (mm/inch)
	GZDSP 4.60ISO	4x 40/50/- W	4x 60 W @ 2 Ohm						optional	4 channel	✓	185 x 40 x 100 7.28 x 1.57 x 3.94
	GZDSP 4.80A-PRO	4x 80/150/- W	2x 350 W @ 4 Ohm						optional	4 channel	✓	185 x 40 x 201 7.28 x 1.57 x 7.87

Competition Amplifiers

Series	Product	Output power @ 4/2/1 Ohm	Bridged @ 4/2 Ohm (link mode)	LPF	HPF / *Subsonic	BP	Bass-boost	Phase-shift	Remote	Line Out	High-level & auto-on	Dimensions (mm/inch)
	GZCA 1.5SPL-M1	1x -/825/1500 W		✓	Subsonic	✓	✓					184 x 55 x 210 4.67 x 2.16 x 8.27
	GZCA 1.5SPL-M2	1x 825/1500/- W		✓	Subsonic	✓	✓					184 x 55 x 210 4.67 x 2.16 x 8.27
	GZCA 3.0SPL-M1	1x -/1800/3400 W		✓	Subsonic	✓	✓					228 x 70 x 236 8.97 x 2.75 x 9.29
	GZCA 3.0SPL-M2	1x 1800/3400/- W		✓	Subsonic	✓	✓					228 x 70 x 236 8.97 x 2.75 x 9.29
	GZCA 5.0SPL-M1	1x -/2800/5600 W		✓	Subsonic	✓	✓					228 x 70 x 315 8.97 x 2.75 x 12.40
	GZCA 5.0SPL-M2	1x 2800/5600/- W		✓	Subsonic	✓	✓					228 x 70 x 315 8.97 x 2.75 x 12.40
	GZCA 8.0SPL-M1	1x -/4480/8960 W		✓	Subsonic	✓	✓					228 x 70 x 401 8.97 x 2.75 x 15.79
	GZCA 8.0SPL-M2	1x 4480/8960/- W		✓	Subsonic	✓	✓					228 x 70 x 401 8.97 x 2.75 x 15.79
	GZCA 12.0SPL-M1	1x -/9000/13700 W		✓	Subsonic	✓	✓					228 x 70 x 523 8.97 x 2.75 x 20.59
	GZCA 12.0SPL-M2	1x 9000/13700/- W		✓	Subsonic	✓	✓					228 x 70 x 523 8.97 x 2.75 x 20.59
	GZCA 20.0SPL-M1	1x -/12000/20000 W		✓	Subsonic	✓	✓					228 x 70 x 861 8.97 x 2.75 x 33.90
	GZCA 35.0SPL-M1	35000 W @ 1 Ohm		✓	Subsonic	✓	✓					228 x 70 x 861 8.97 x 2.75 x 33.90
	GZCA 750.2-D1	2x -/400/750 W	1x 1500 W max @ 2 Ohm	✓	✓							184 x 55 x 172 4.67 x 2.16 x 6.77
	GZCA 750.2-D2	2x 400/750/- W	1x 1500 W max @ 4 Ohm	✓	✓							184 x 55 x 172 4.67 x 2.16 x 6.77
	GZCA 1500.2-D1	2x -/900/1500 W	1x 3000 W max @ 2 Ohm	✓	✓							228 x 70 x 182 8.97 x 2.75 x 7.16
	GZCA 1500.2-D2	2x 900/1500/- W	1x 3000 W max @ 4 Ohm	✓	✓							227.5 x 70 x 182 8.95 x 2.75 x 7.16

Active Subwoofers

Series	Product	Woofers	Type	Enclosure	Dimensions (mm/inch)	Lowpass	Bass remote	Output power
	GZUB 600XACTII	160 mm / 6" Flat woofer	Flat active woofer	Aluminum cast	290 x 203 x 72 / 11.42 x 7.99 x 2.83"	50 - 100 Hz	✓	100 / 160 W
	GZUB 800XACTII	200 mm / 8" Flat woofer	Flat active woofer	Aluminum cast	345 x 240 x 68 / 13.58 x 9.45 x 2.68"	50 - 100 Hz	✓	120 / 180 W
	GZUB 1000XACTII	250 mm / 10" Flat woofer	Flat active woofer	Aluminum cast	360 x 270 x 78 / 14.17 x 10.63 x 3.07"	50 - 100 Hz	✓	150 / 210 W
	GZTB 20ACT	200 mm / 8" Flat woofer	Flat active woofer	Plastic injection	345 x 237 x 72 / 13.58 x 9.33 x 2.83"	50 - 100 Hz	✓	100 / 160 W
	GZTB 25ACT	250 mm / 10" Flat woofer	Flat active woofer	Plastic injection	360 x 276 x 76 / 14.17 x 10.87 x 2.99"	50 - 100 Hz	✓	100 / 160 W
	GZIB 200XBR-ACT	200 mm / 8" Subwoofer	Front-Basstunnel	17 L / 0.6 ft³ Wood	380 x 260 x 310 (245) / 15 x 10.24 x 12.2 (9.65")	30 - 120 Hz	optional	100 / 200 W
	GZIB 250XBR-ACT	250 mm / 10" Subwoofer	Front-Basstunnel	26 L / 0.92 ft³ Wood	400 x 270 x 313 (245) / 15.75 x 10.63 x 12.32 (9.65")	30 - 120 Hz	optional	150 / 270 W
	GZIB 300XBR-ACT	300 mm / 12" Subwoofer	Front-Basstunnel	37 L / 1.31 ft³ Wood	460 x 370 x 400 (310) / 18.11 x 14.57 x 15.75 (12.2")	30 - 120 Hz	optional	180 / 300 W
	GZCS 10SUB-ACT	250 mm / 10" Woofer	Sealed	15 L / 0.53 ft³	620 x 440 x 120 (153 incl. feet) / 24.4 x 17.32 x 4.72 (5.98" incl. feet)	30 - 120 Hz	optional	150 / 300 W

Subwoofer Enclosures

Series

Product	Woofers	Type	Net. Volume	Dimensions (mm/inch)	Impedance	Power handling	Recommended amplifier power
GZTB 120F	GZTW 12F	Sealed	29.5 L / 1.04 ft ³	725 x 385 x 110 (195) / 28.54 x 15.16 x 4.33 (7.68")	2 x 2 Ω	350 WRMS	200 - 500 W
GZIB 200XBR	200 mm / 8"	Front-Basstunnel	17 L / 0.6 ft ³	380 x 260 x 290 (230) / 15 x 10.24 x 11.42 (9.06)	4 Ω	150 WRMS	100 - 200 W
GZIB 250XBR	250 mm / 10"	Front-Basstunnel	26L / 0,92 ft ³	400 x 270 x 313 (245)/ 15.75 x 10.63 x 12.32 (9.65")	4 Ω	250 WRMS	150 - 270 W
GZIB 300XBR	300 mm / 12"	Front-Basstunnel	37 L / 1.31 ft ³	440 x 365 x 390 (300) / 17.32 x 14.37 x 15.35 (12")	4 Ω	350 WRMS	250 - 400 W
GZIB 2.300XBR	2 x 300 mm / 12"	Front-Basstunnel	70 L / 2.47 ft ³	820 x 365 x 390 (290) / 32.28 x 14.37 x 15.35 (11.4")	2 x 2 Ω	700 WRMS	500 - 800 W
GZIB 3000XSPL	GZIW 12XSPL	Front-Basstunnel	45 L / 1.59 ft ³	560 x 360 x 360 (260) / 22.05 x 14.17 x 14.17 (10.24)	2 x 2 Ω	1000 W SPL	600 - 1000 W
GZIB 2.3000XSPL	2 x GZIW 12XSPL	Front-Basstunnel	90 L / 3.54 ft ³	840 x 400 x 430 (310)/ 33.07 x 15.75 x 16.93 (12.2")	4 x 2 Ω	2000 W SPL	1200 - 2000 W
GZCS 10SUB	250 mm / 10"	Sealed	15 L / 0.53 ft ³	620 x 440 x 120 (145 incl. feet) / 24.4 x 17.32 x 4.72 (5.71" incl. feet)	2 x 2 Ω	150 WRMS	100 - 300 W

Speaker Systems

Series

Product	Outer Ø	Mounting Ø	Depth	Tweeter	Midwoofer	Frequency range	Impedance	Power handling RMS/MAX
GZPC 16.3SQ-ACT	165 mm / 6.5" 94 mm / 3.7"	143.5 mm / 5.65" 76.5 mm / 3.01"	68 mm / 2.68" 34 mm / 1.34"	GZPT 28SX	GZPK 16SQ GZPM 80SQX-II	30 Hz - 30 kHz	4 / 4 / 4 Ω	300 / 480 W
GZPC 165SQ-ACT	165 mm / 6.5"	143.5 mm / 5.65"	68 mm / 2.68"	GZPT 28SX	GZPK 16SQ	30 Hz - 30 kHz	4 / 4 Ω	210 / 330 W
GZPC 165.2SQF-ACT	165 mm / 6.5"	143.5 mm / 5.65"	68 mm / 2.68"	GZPF 40SQ	GZPK 16SQ	30 Hz - 22 kHz	4 / 4 Ω	180 / 270 W
GZNC 165.3SQ-ACT	165 mm / 6.5" 94 mm / 3.7"	143.5 mm / 5.65" 76.5 mm / 3.01"	68 mm / 2.68" 34 mm / 1.34"	GZNT 25SQ	GZNK 165SQ GZNM 80SQ	40 Hz - 26 kHz	4 / 4 / 4 Ω	250 / 360 W
GZNC 165.2SQ-ACT	165 mm / 6.5"	143.5 mm / 5.65"	68 mm / 2.68"	GZNT 25SQ	GZNK 165SQ	40 Hz - 26 kHz	4 / 4 Ω	190 / 280 W
GZNC 1650SQ	165 mm / 6.5"	143.5 mm / 5.65"	68 mm / 2.68"	GZNT 25SQ	GZNK 165SQ	40 Hz - 26 kHz	4 Ω	150 / 250 W
GZUC 65.3SQX	165 mm / 6.5" 72.5 mm / 2.85"	142 mm / 5.59" 61.5 mm / 2.42"	70 mm / 2.76" 34 mm / 1.34"	GZUT 25SQX	GZUK 65SQX GZUF 60SQX	40 Hz - 25 kHz	4 / 4 Ω	220 / 350 W
GZUC 650SQX	165 mm / 6.5"	142 mm / 5.59"	70 mm / 2.76"	GZUT 25SQX	GZUK 65SQX	40 Hz - 25 kHz	4 Ω	140 / 220 W
GZUC 650SQ-II	165 mm / 6.5"	145.7 mm / 5.74"	66 mm / 2.6"	25 mm / 1" softdome	WFVC Cone	40 Hz - 24 kHz	4 Ω	130 / 210 W
GZRC 165.3SQ	165 mm / 6.5" 94 mm / 3.7"	142.5 mm / 5.61" 67.5 mm / 3.01"	68 mm / 2.68" 34 mm / 1.34"	GZRT 25SQ	Aluminum cone	35 Hz - 25 kHz	3 Ω	170 / 270 W
GZRC 165.2SQ	165 mm / 6.5"	142.5 mm / 5.61"	68 mm / 2.68"	GZRT 25SQ	Aluminum cone	35 Hz - 25 kHz	3 Ω	120 / 190 W
GZRC 130AL-IV	130 mm / 5.12"	117.5 mm / 4.63"	60 mm / 2.36"	GZRT 25T	Aluminum cone	60 Hz - 26 kHz	3 Ω	100 / 160 W
GZRC 165AL-IV	165 mm / 6.5"	142.5 mm / 5.61"	68 mm / 2.68"	GZRT 25T	GZRC 16AL	35 Hz - 26 kHz	3 Ω	120 / 190 W
GZRC 100NEO-IV	102 mm / 4.02"	94 mm / 3.7"	31 mm / 1.22"	GZRT 25T	Coated paper cone	80 Hz - 26 kHz	3 Ω	80 / 120 W
GZRC 165NEO-IV	165 mm / 6.5"	142.5 mm / 5.61"	48 mm / 1.89"	GZRT 25T	GZMW 165X-NEO	50 Hz - 26 kHz	3 Ω	110 / 170 W
GZRC 200NEO-IV	205 mm / 8.07"	182 mm / 7.17"	57 mm / 2.24"	GZRT 25T	GZMW 200X-NEO	35 Hz - 26 kHz	3 Ω	120 / 190 W
GZTC 130	130 mm / 5.12"	117.5 mm / 4.61"	61 mm / 2.40"	19 mm / 0.75" silk dome	HQPP cone	60 Hz - 22 kHz	3 Ω	80 / 130 W
GZTC 165	165 mm / 6.5"	142.5 mm / 5.61"	68 mm / 2.68"	19 mm / 0.75" silk dome	HQPP cone	50 Hz - 22 kHz	3 Ω	100 / 150 W
GZTC 165.3	165 mm / 6.5" 10.2 mm / 4.02"	142.5 mm / 5.61" 95 mm / 3.74"	68 mm / 2.68" 32 mm / 1.26"	19 mm / 0.75" silk dome	HQPP cone	50 Hz - 22 kHz	3 Ω	120 / 180 W
GZIC 13X	130 mm / 5.25"	114 mm / 4.49"	50 mm / 1.97"	19 mm / 0.75" softdome	HQPP cone	60 Hz - 20 kHz	4 Ω	90 / 140 W
GZIC 16X	165 mm / 6.5"	143.5 mm / 5.65"	60 mm / 2.36"	19 mm / 0.75" softdome	HQPP cone	50 Hz - 20 kHz	4 Ω	100 / 150 W
GZIC 400FX	102 mm / 4.02"	93 mm / 3.66"	30 mm / 1.18"	19 mm / 0.75" softdome	Coated paper cone	70 Hz - 20 kHz	4 Ω	60 / 100 W
GZIC 650FX	165 mm / 6.5"	142.5 mm / 5.61"	44 mm / 1.73"	19 mm / 0.75" softdome	Coated paper cone	50 Hz - 20 kHz	4 Ω	100 / 140 W
GZCC 165.2SQL	167 mm / 6.57"	145 mm / 5.7"	71.5 mm / 2.81"	25 mm / 1" coated soft dome	Fiber reinforced paper cone	50 Hz - 22 kHz	4 Ω	160 / 300 W
GZCC 200.2SQL	209 mm / 8.23"	183 mm / 7.2"	86 mm / 3.39"	25 mm / 1" coated soft dome	Fiber reinforced paper cone	50 Hz - 22 kHz	4 Ω	200 / 380 W
GZCS 100BMW-A		Car specific		25 mm / 1" titanium dome	Paper-fibre cone	100 Hz - 26 kHz	3 Ω	50 / 100 W
GZCS 100BMW-B		Car specific		25 mm / 1" titanium dome	Paper-fibre cone	100 Hz - 26 kHz	3 Ω	50 / 100 W
GZCS 100BMW-C		Car specific		25 mm / 1" titanium dome	Paper-fibre cone	100 Hz - 26 kHz	3 Ω	50 / 100 W
GZCS 100BMW-D		Car specific		25 mm / 1" titanium dome	Paper-fibre cone	100 Hz - 26 kHz	3 Ω	50 / 100 W
GZCS 100BMW-SA		Car specific		25 mm / 1" silk dome	Paper-fibre cone	100 Hz - 25 kHz	3 Ω	50 / 100 W
GZCS 100BMW-SB		Car specific		25 mm / 1" silk dome	Paper-fibre cone	100 Hz - 25 kHz	3 Ω	50 / 100 W
GZCS 100BMW-SC		Car specific		25 mm / 1" silk dome	Paper-fibre cone	100 Hz - 25 kHz	3 Ω	50 / 100 W
GZCS 100BMW-SD		Car specific		25 mm / 1" silk dome	Paper-fibre cone	100 Hz - 25 kHz	3 Ω	50 / 100 W
GZCS 100MB		Car specific		25 mm / 1" silk dome	HQPP cone	70 Hz - 30 kHz	4 Ω	50 / 100 W
GZCS 100MINI-A		Car specific		25 mm / 1" titanium dome	Paper-fibre cone	100 Hz - 26 kHz	3 Ω	50 / 100 W
GZCS 165VW		Car specific		25 mm / 1" titanium dome	Aluminum cone	35 Hz - 26 kHz	3 Ω	120 / 190 W
GZCS 200VW-T6		Car specific		28 mm / 1.1" silk dome	Pressed paper cone	40 Hz - 25 kHz	3 Ω	100 / 160 W

Coaxial Speakers									
Series	Product	Outer Ø	Mounting Ø	Depth	Tweeter	Midwoofer	Frequency range	Impedance	Power handling RMS/MAX
Yellow	GZRF 40AL	102 mm / 4.02"	93 mm / 3.66"	47 mm / 1.85"	13 mm / 0.51" PEI	Aluminum cone	70 Hz - 20 kHz	3 Ω	70 / 110 W
	GZRF 52AL	130 mm / 5.25"	117.5 mm / 4.63"	59 mm / 2.32"	13 mm / 0.51" PEI	Aluminum cone	60 Hz - 20 kHz	3 Ω	80 / 120 W
	GZRF 65AL	165 mm / 6.5"	142.5 mm / 5.61"	68 mm / 2.68"	13 mm / 0.51" PEI	Aluminum cone	50 Hz - 25 kHz	3 Ω	100 / 140 W
	GZRF 69AL	150 x 230 mm / 6 x 9"	152 x 214 mm / 5.98 x 8.4"	82 mm / 3.23"	13 mm / 0.51" PEI 50 mm / 2" PEI	Aluminum cone	40 Hz - 25 kHz	3 Ω	130 / 200 W
Red	GZRM 165X	165 mm / 6.5"	142.5 mm / 5.61"	62 mm / 2.44"	13 mm / 0.51" Mylar	IMPP cone	60 Hz - 25 kHz	4 Ω	70 / 120 W
	GZTF 10	102 mm / 4.02"	93 mm / 3.66"	51 mm / 2.01"	13 mm / 0.51" Mylar	HQPP cone	70 Hz - 22 kHz	3 Ω	70 / 100 W
	GZTF 13	130 mm / 5.25"	117.5 mm / 4.63"	62 mm / 2.44"	13 mm / 0.51" Mylar	HQPP cone	60 Hz - 22 kHz	3 Ω	80 / 110 W
	GZTF 16	165 mm / 6.5"	143.5 mm / 5.65"	67 mm / 2.64"	13 mm / 0.51" Mylar	HQPP cone	50 Hz - 22 kHz	3 Ω	90 / 130 W
Orange	GZTF 69	150 x 230 mm / 6 x 9"	152 x 214 mm / 5.98 x 8.4"	85 mm / 3.35"	13 mm / 0.51" Mylar 55 mm / 2.2" Mylar	HQPP cone	40 Hz - 22 kHz	3 Ω	130 / 190 W
	GZIF 40X	102 mm / 4.02"	92 mm / 3.6"	47 mm / 1.85"	13 mm / 0.51" Mylar	HQPP cone	80 Hz - 20 kHz	4 Ω	60 / 100 W
	GZIF 4001FX	102 mm / 4.02"	93 mm / 3.66"	30 mm / 1.18"	13 mm / 0.51" Mylar	Coated paper cone	80 Hz - 20 kHz	4 Ω	50 / 90 W
	GZIF 52X	130 mm / 5.25"	114 mm / 4.49"	50 mm / 1.97"	13 mm / 0.51" Mylar	HQPP cone	60 Hz - 20 kHz	4 Ω	70 / 110 W
Green	GZIF 5201FX	130 mm / 5.25"	117.5 mm / 4.63"	37 mm / 1.46"	13 mm / 0.51" Mylar	Coated paper cone	70 Hz - 20 kHz	4 Ω	60 / 100 W
	GZIF 65X	165 mm / 6.5"	143.5 mm / 5.65"	60 mm / 2.36"	13 mm / 0.51" Mylar	HQPP cone	50 Hz - 20 kHz	4 Ω	80 / 120 W
	GZIF 6501FX	165 mm / 6.5"	142.5 mm / 5.61"	44 mm / 1.73"	13 mm / 0.51" Mylar	Coated paper cone	60 Hz - 20 kHz	4 Ω	70 / 110 W
	GZIF 69X	150 x 230 mm / 6 x 9"	150 x 220 mm / 5.9 x 8.66"	81.5 mm / 3.2"	13 mm / 0.51" Mylar 50 mm / 2" Mylar	HQPP cone	40 Hz - 20 kHz	4 Ω	120 / 180 W
Purple	GZCF 165COAX	169 mm / 6.65"	147.5 mm / 5.8"	79 mm / 3.11"	35 mm / 1.38" PEN compression horn	Fiber reinforced paper cone	TW: 3.5 - 25 kHz MID: 180 Hz - 3.5 kHz	TW: 4 Ω MID: 4 Ω	TW: 25 / 100 W Mid: 125 / 200 W
	GZCF 200COAX	210 mm / 8.27"	184 mm / 7.24"	89 mm / 3.5"	44.5 mm / 1.75" titanium compression horn	Fiber reinforced paper cone	TW: 3 - 25 kHz MID: 150 Hz - 3 kHz	TW: 4 Ω MID: 4 Ω	TW: 50 / 150 W Mid: 150 / 250 W
	GZCF 7104XSPL	180 x 250 mm / 7 x 10"	6 x 9" Adapter	86 mm / 3.39"	13 mm / 0.51" PEI 50 mm / 2" paper cone 13mm / 0.51" piezo	Fiber reinforced paper cone	35 Hz - 25 kHz	4 Ω	200 / 300 W
Blue	GZCS 12CX	Car specific			13 mm / 0.51" Mylar	Coated paper cone	75 Hz - 20 kHz	4 Ω	60 / 100 W
	GZCS 46CX	100 x 150 mm / 4 x 6"	90 x 141 mm / 3.54 x 5.55"	48 mm / 1.89"	13 mm / 0.51" Mylar	Coated paper cone	80 Hz - 20 kHz	4 Ω	70 / 110 W
	GZCS 8.7CX	87 mm / 3.43"	80 mm / 3.15"	43 mm / 1.69"	13 mm / 0.51" Mylar	Coated paper cone	100 Hz - 20 kHz	4 Ω	50 / 90 W
Cyan	GZMS 65LED	165 mm / 6.5"		225 mm / 8.86"	25 mm / 1" PEI	IMPP cone	70 Hz - 22 kHz	4 Ω	60 / 120 W

Kickwoofer / Midwoofer / Midrange / Fullrange Speakers												
Series	Product	Outer Ø	Mounting Ø	Depth	Voice coil Ø	Cone	FS	QTS	VAS	Frequency range	Impedance	Power handling RMS/MAX
Orange	GZMW Reference 180	181 mm / 7.13"	155.5 mm / 6.12"	68 mm / 2.68"	25 mm / 1"	Coated paper	56.8 Hz	0.58	16 L / 0.56 ft³	40 Hz - 3.5 kHz	4 Ω	100 / 150 W
	GZPM Reference 80	98 mm / 3.86"	85.4 mm / 3.36"	45 mm / 1.77"	19 mm / 0.75"	Coated paper	107.5 Hz	0.6	0.8 L / 0.028 ft³	150 Hz - 6 kHz	4 Ω	80 / 120 W
Red	GZPF 40SQ	54 mm / 2.1"	48 mm / 1.89"	39 mm / 1.54"	16 mm / 0.63"	Aluminum	400 Hz			500 Hz - 24 kHz	4 Ω	50 / 80 W
	GZPM 80SQX-II	94 mm / 3.7"	77 mm / 3.03"	34 mm / 1.34"	25 mm / 1"	Aluminum	109.4 Hz	0.46	0.9 L / 0.032 ft³	150 Hz - 4 kHz	4 Ω	70 / 110 W
Blue	GZPK 165SQ	165 mm / 6.5"	143.5 mm / 5.65"	68 mm / 2.68"	36 mm / 1.42"	Alu-Ceramic	45.3 Hz	0.62	22.1 L / 0.78 ft³	30 Hz - 3 kHz	4 Ω	130 / 210 W
	GZNF 50SQ	72 mm / 2.83"	50 mm / 1.97"	30 mm / 1.18"	22 mm / 0.87"	Black Aluminum	130 Hz			250 Hz - 22 kHz	4 Ω	50 / 80 W
Cyan	GZNM 80SQ	94 mm / 3.7"	76.5 mm / 3.01"	34 mm / 1.34"	25 mm / 1"	Coated paper	115 Hz	0.39	1 L / 0.035 ft³	150 Hz - 5 kHz	4 Ω	60 / 100 W
	GZNK 165SQ	165 mm / 6.5"	143.5 mm / 5.65"	68 mm / 2.68"	36 mm / 1.42"	Coated paper	55.2 Hz	0.65	14.6 L / 0.52 ft³	40 Hz - 3 kHz	4 Ω	130 / 200 W
Purple	GZUF 60SQX	72 mm / 2.83"	61 mm / 2.4"	36 mm / 1.42"	25 mm / 1"	Black Aluminum	150 Hz	0.64	0.4 L / 0.14 ft³	300 Hz - 20 kHz	4 Ω	50 / 80 W
	GZUK 65SQX	165 mm / 6.5"	142 mm / 5.59"	70 mm / 2.76"	31 mm / 1.22"	WFVC	55.1 Hz	0.49	12.6 L / 0.45 ft³	40 Hz - 4 kHz	4 Ω	120 / 200 W
Yellow	GZRM 80SQ	94 mm / 3.7"	76.5 mm / 3.01"	34 mm / 1.34"	25 mm / 1"	Aluminum	113 Hz	0.38	1.5 L / 0.52 ft³	160 Hz - 4 kHz	3 Ω	50 / 80 W
	GZRK 165SQ	165 mm / 6.5"	142.5 mm / 5.61"	68 mm / 2.68"	25 mm / 1"	Aluminum	60.1 Hz	0.65	11.5 L / 0.41 ft³	35 Hz - 4 kHz	3 Ω	110 / 160 W
Orange	GZRK 16AL	165 mm / 6.5"	142.5 mm / 5.61"	68 mm / 2.68"	25 mm / 1"	Aluminum	60.1 Hz	0.65	11.5 L / 0.41 ft³	35 Hz - 4 kHz	3 Ω	110 / 160 W
	GZMW 165X-NEO	165 mm / 6.5"	142.5 mm / 5.61"	48 mm / 1.89"	30 mm / 1.18"	Coated paper	44.3 Hz	0.47	21.4 L / 0.76 ft³	50 Hz - 4 kHz	3 Ω	90 / 140 W
Red	GZCM 6.5N-PRO	173 mm / 6.81"	148 mm / 5.83"	68 mm / 2.68"	38 mm / 1.5"	Reinforced paper	116.2 Hz	0.33	5.6 L / 0.20 ft³	150 Hz - 12 kHz	4 Ω	200 / 400 W
	GZCM 8.0N-PRO	209 mm / 8.23"	184 mm / 7.24"	83 mm / 3.27"	63 mm / 2.5"	Reinforced paper	102.2 Hz	0.28	9.1 L / 0.32 ft³	130 Hz - 10 kHz	4 Ω	300 / 500 W
	GZCW 12.1200-PRO	320 mm / 12.6"	283 mm / 11.14"	117 mm / 4.6"	100 mm / 4"	Reinforced paper	51.4 Hz	0.28	43.8 L / 1.55 ft³	60 Hz - 2 kHz	4 Ω	800/1200W

Kickwoofer / Midwoofer / Midrange Speakers

Series	Product	Outer Ø	Mounting Ø	Depth	Voice coil Ø	Cone	FS	QTS	VAS	Frequency range	Impedance	Power handling RMS/MAX
	GZCM 6.5SPL	165 mm / 6.5"	143 mm / 5.63"	72 mm / 2.83"	38 mm / 1.5"	Reinforced paper	189.4 Hz	0.96	1.9 L / 0.067 ft³	250 Hz - 10 kHz	4 Ω	100 / 300 W
	GZCK 165SPL	167 mm / 6.57"	145 mm / 5.7"	71.5 mm / 2.81"	38 mm / 1.5"	Reinforced paper	56.8 Hz	0.31	16.2 L / 0.57 ft³	50 Hz - 4 kHz	4 Ω	100 / 250 W
	GZCM 6-4PPX	173 mm / 6.81"	148 mm / 5.83"	82 mm / 3.23"	50 mm / 2"	Reinforced paper	126.5 Hz	0.46	4.8 / 0.17 ft³	150 Hz - 10 kHz	4 Ω	150 / 400 W
	GZCM 6-4FX	165 mm / 6.5"	143 mm / 5.63"	52 mm / 2.05"	38 mm / 1.5"	Reinforced paper	216.6 Hz	0.94	1.8 l / 0.06 ft³	200 Hz - 5 kHz	4 Ω	100 / 300 W
	GZCM 8.0SPL	206 mm / 8.11"	182 mm / 7.17"	87 mm / 3.43"	38 mm / 1.5"	Reinforced paper	90.6 Hz	0.58	17.2 L / 0.607 ft³	170 Hz - 10 kHz	4 Ω	150 / 400 W
	GZCK 200SPL	209 mm / 8.23"	183 mm / 7.2"	86 mm / 3.39"	38 mm / 1.5"	Reinforced paper	54.3 Hz	0.38	31.2 L / 1.10 ft³	50 Hz - 6 kHz	4 Ω	150 / 300 W
	GZCM 8-4PPX	209 mm / 8.23"	184 mm / 7.24"	92 mm / 3.62"	50 mm / 2"	Reinforced paper	124.3 Hz	0.47	6.8 L / 0.24 ft³	150 Hz - 10 kHz	4 Ω	200 / 500 W
	GZCM 8-4FX	210 mm / 8.27"	180 mm / 7.09"	65 mm / 2.56"	38 mm / 1.5"	Reinforced paper	132.1 Hz	1, 02	6.3 L / 0.22 ft³	150 Hz - 4 kHz	4 Ω	100 / 400 W
	GZCM 10.0SPL	258 mm / 10.16"	231 mm / 9.09"	98 mm / 3.86"	50 mm / 2"	Reinforced paper	76.2 Hz	0.65	31 L / 1.095 ft³	150 Hz - 10 kHz	4 Ω	200 / 500 W
	GZCK 250SPL	255 mm / 10.04"	230 mm / 9.06"	107 mm / 4.21"	50 mm / 2"	Reinforced paper	45.4 Hz	0.36	67.9 L / 2.4 ft³	50 Hz - 6 kHz	4 Ω	200 / 400 W
	GZCM 10-4PPX	261 mm / 10.28"	232 mm / 9.13"	108 mm / 4.25"	75 mm / 3"	Reinforced paper	117.9 Hz	0.65	10.4 L / 0.37 ft³	120 Hz - 5 kHz	4 Ω	300 / 600 W
	GZCM 10-4FX	257 mm / 10.12"	230 mm / 9.06"	76 mm / 2.99"	50 mm / 2"	Reinforced paper	91.2 Hz	0.69	23.5 L / 0.83 ft³	120 Hz - 5 kHz	4 Ω	200 / 500 W
	GZCW 12-50	312 mm / 12.28"	282 mm / 11.1"	130 mm / 5.12"	50 mm / 2"	Reinforced paper	47.1 Hz	0.42	93.4 L / 3.68 ft³	50 Hz - 3 kHz	4 Ω	300 / 600 W
	GZCW 12-75SPL	312 mm / 12.28"	282 mm / 11.1"	133 mm / 5.24"	75 mm / 3"	Reinforced paper	42.2 Hz	0.27	71.9 L / 2.54 ft³	40 Hz - 3 kHz	4 Ω	400 / 800 W

Competition & Competition PRO Tweeters

Series	Product	Outer Ø w/o frame	Outer Ø incl. frame	Mounting Ø incl. frame	Voice coil Ø	Dome	Frequency range	Impedance	Power handling RMS/MAX
	GZCT 19N-PROX	83 x 67 mm / 3.27 x 2.64"	60 x 46 / 2.36 x 1.81"	48 mm / 1.89"	25 mm / 1"	Titanium	3 - 22 kHz	4 Ω	30 / 100 W
	GZCT 25SQL	75 mm / 2.95"	50 mm / 1.97"	36 mm / 1.42"	25 mm / 1"	Coated silk	3 - 22 kHz	4 Ω	100 / 150 W
	GZCT 0500X	58 mm / 2.28"	43 mm / 1.69"	43 mm / 1.69"	25 mm / 1"	Aluminum	4 - 25 kHz	4 Ω	30 / 100 W
	GZCT 500IV-B	58 mm / 2.28"	43 mm / 1.69"	37 mm / 1.46"	25 mm / 1"	Aluminum	4 - 25 kHz	4 Ω	30 / 100 W
	GZCT 1000X	100 x 75 mm / 4 x 3"	82 x 58 / 3.23 x 2.28"	56 mm / 2.2"	25 mm / 1"	Aluminum	5 - 20 kHz	4 Ω	30 / 100 W
	GZCT 2100X-B	89 x 89 mm / 3.5 x 3.5"	80 mm / 3.15"	42.5 mm / 1.67"	25 mm / 1"	Aluminum	3 - 25 kHz	4 Ω	30 / 100 W
	GZCT 3000X	102 x 102 mm / 4.02 x 4.02"	90 mm / 3.54"	66 mm / 2.6"	38 mm / 1.5"	Aluminum	4 - 25 kHz	4 Ω	40 / 120 W
	GZCT 3500X	98 mm / 3.86"		40 mm / 1.57"	25 mm / 1"	Aluminum	3 - 25 kHz	4 Ω	30 / 100 W
	GZCT 4000X	160 x 120 mm / 6.3 x 4.7"	128 x 88 / 5 x 3.46"	87 mm / 3.43"	44.5 mm / 1.75"	Aluminum	2.5 - 20 kHz	4 Ω	50 / 140 W
	GZCT 5000SPL	200 x 150 mm / 8 x 5.9"	165 x 130 / 6.5 x 5.12"	142 mm / 5.59"	44.5 mm / 1.75"	Titanium	1.5 - 20 kHz	4 Ω	70 / 180 W

Tweeters

Series	Product	Outer Ø w/o frame	Outer Ø incl. frame	Mounting Ø incl. frame	Total height w/o frame	Mounting depth incl. frame	Voice coil Ø	Dome	FS	Frequency range	Impedance	Power handling RMS/MAX
	GZPT Reference 28EVO	n.a.	54 mm / 2.1"	48 mm / 1.89"	n.a.	39 mm / 1.54"	28 mm / 1.1"	Coated silk	630 Hz	1 - 30 kHz	4 Ω	100 / 150 W
	GZPT 28SX	n.a.	54 mm / 2.1"	48 mm / 1.89"	n.a.	31 mm / 1.22"	28 mm / 1.1"	Coated silk	750 Hz	2 - 30 kHz	4 Ω	100 / 150 W
	GZNT 22SQ	39.5 mm / 1.56"	49.5 mm / 1.95"	44 mm / 1.73"	30 mm / 1.18"	23.1 mm / 0.91"	22 mm / 0.87"	Coated silk	825 Hz	2 - 30 kHz	4 Ω	60 / 100 W
	GZNT 25SQ	n.a.	49 mm / 1.93"	43.1 mm / 1.7"	n.a.	21.5 mm / 0.85"	25 mm / 1"	Coated silk	750 Hz	2 - 28 kHz	4 Ω	80 / 130 W
	GZUT 25SQX	n.a.	49.5 mm / 1.95"	44 mm / 1.73"	n.a.	22 mm / 0.87"	25 mm / 1"	Coated silk	750 Hz	2 - 25 kHz	4 Ω	70 / 120 W
	GZRT 25SQ	44 mm / 1.73"	54 mm / 2.13"	48 mm / 1.89"	18 mm / 0.71"	16 mm / 0.63"	25 mm / 1"	Coated silk	1550 Hz	3 - 25 kHz	4 Ω	70 / 110 W
	GZRT 25T	n.a.	49.5 mm / 1.95"	44 mm / 1.73"	n.a.	10 mm / 0.39"	25 mm / 1"	Titanium	1500 Hz	3 - 26 kHz	3 Ω	70 / 110 W
	GZHT 19X	37 mm / 1.46"	50 mm / 1.97"	41 mm / 1.61"	18 mm / 0.71"	15 mm / 0.59"	19 mm / 0.75"	Coated silk	1650 Hz	3.5 - 20 kHz	4 Ω	40 / 70 W
	GZHT 25X	42 mm / 1.65"	54 mm / 2.13"	48 mm / 1.89"	21 mm / 0.83"	20 mm / 0.79"	25 mm / 1"	Coated silk	1600 Hz	3 - 20 kHz	4 Ω	60 / 100 W

Subwoofers												
Series	Product	Outer Ø	Mounting Ø	Depth	Voice coil Ø	Cone	FS	QTS	VAS	Impedance	Power handling	Recommended amplifier power
	GZPW Reference 250	275 mm / 10.8"	235 mm / 9.25"	128 mm / 5.04"	50 mm / 2"	3 layer sandwich	31.3 Hz	0.4	36.5 L / 1.29 ft³	2 x 2 Ω	500 W RMS	300 - 600 W
	GZPW 10SQ	259 mm / 10.20"	236 mm / 9.29"	148 mm / 5.83"	50 mm / 2"	Aluminum	34 Hz	0.58	23.54 L / 0.831 ft³	2 x 2 Ω	400 W RMS	300 - 500 W
	GZPW 15NEO-SPL	391 mm / 15.39"	358 mm / 14.09"	307 mm / 12.09"	100 mm / 4"	Carbon fiber mixed	41.2 Hz	0.19	25.6 L / 0.9 ft³	2 x 1 Ω	3000 W RMS	2000 - 10000 W
	GZPW 15Xmax	392 mm / 15.43"	358 mm / 14.09"	313 mm / 12.32"	100 mm / 4"	Aluminum	33.3 Hz	0.44	22.8 L / 0.8 ft³	2 x 1 Ω	6000 W RMS	4000 - 8000 W
	GZNW 38NEO-SPL	391 mm / 15.39"	358 mm / 14.09"	300 mm / 11.81"	75 mm / 3"	Reinforced paper	25.8 Hz	0,11	50.8 L / 1.794 ft³	2 x 1 Ω	2500 W RMS	1500 - 5000 W
	GZNW 12SPL-Xflex	314 mm / 12.33"	284 mm / 11.18"	226 mm / 8.9"	75 mm / 3"	Reinforced paper	33.9 Hz	0,36	27.3 L / 0.96 ft³	2 x 1 Ω	2500 W RMS / 4500 W SPL	1500 - 4500 W
	GZNW 15SPL-Xflex	392 mm / 15.43"	358 mm / 14.09"	260 mm / 10.24"	75 mm / 3"	Reinforced paper	30.2 Hz	0,49	59.1 L / 2.087 ft³	2 x 1 Ω	3000 W RMS / 5500 W SPL	2000 - 5500 W
	GZNW 18SPL-Xflex	465 mm / 18.3"	425 mm / 16.73"	286 mm / 11.26"	75 mm / 3"	Reinforced paper	27 Hz	0,56	147 L / 5.19 ft³	2 x 1 Ω	3000 W RMS / 6500 W SPL	2000 - 6500 W
	GZNW 12Xmax	314 mm / 12.36"	282 mm / 11.1"	250 mm / 9.84"	75 mm / 3"	Aluminum	35.6 Hz	0.61	13.59 L / 0.48 ft³	2 x 1 Ω	3000 W RMS	2000 - 4000 W
	GZNW 15Xmax	392 mm / 15.43"	358 mm / 14.09"	285 mm / 11.22"	75 mm / 3"	Aluminum	29.5 Hz	0.33	35.72 L / 1.26 ft³	2 x 1 Ω	4000 W RMS	3000 - 5000 W
	GZUW 8SQX	215 mm / 8.46"	181 mm / 7.13"	108 mm / 4.25"	50 mm / 2"	Reinforced paper	56.4 Hz	0.68	5.9 L / 0.21 ft³	2 x 2 Ω	300 W RMS	200 - 400 W
	GZUW 10SQX	262 mm / 10.31"	236 mm / 9.29"	148 mm / 5.83"	50 mm / 2"	Reinforced paper	46.7 Hz	0.62	14.2 L / 0.5 ft³	2 x 2 Ω	450 W RMS	300 - 600 W
	GZUW 12SQX	315 mm / 12.4"	281 mm / 11.06"	150 mm / 5.91"	50 mm / 2"	Reinforced paper	38.6 Hz	0.62	41.1 L / 1.45 ft³	2 x 2 Ω	600 W RMS	400 - 800 W
	GZHW 16SPL	177 mm / 6.97"	153 mm / 6.02"	110 mm / 4.33"	50 mm / 2"	Reinforced paper	51 Hz	0.46	2.8 L / 0.10 ft³	2 x 2 Ω	500 W RMS / 1000 W SPL	400 - 1000 W
	GZHW 20SPL	211 mm / 8.31"	187 mm / 7.36"	143 mm / 5.65"	63 mm / 2.5"	Reinforced paper	38.3 Hz	0.38	4.77 L / 0.17 ft³	2 x 1 Ω	700 W RMS / 1500 W SPL	500 - 1500 W
	GZHW 25SPL	274 mm / 10.79"	238 mm / 9.37"	178 mm / 7"	63 mm / 2.5"	Reinforced paper	41.8 Hz	0,48	8.53 / 0.3 ft³	2 x 1 Ω	1200 W RMS / 2500 W SPL	800 - 2500 W
	GZHW 30SPL	315 mm / 12.4"	284 mm / 11.18"	19.8 mm / 7.8"	75 mm / 3"	Reinforced paper	35.4 Hz	0.44	15.8 L / 0.56 ft³	2 x 1 Ω	1500 W RMS / 3000 W SPL	1000 - 3000 W
	GZHW 38SPL	390 mm / 15.35"	360 mm / 14.17"	23.1 mm / 9.09"	75 mm / 3"	Reinforced paper	36.3 Hz	0.52	32.84 L / 1.6 ft³	2 x 1 Ω	2000 W RMS / 3500 W SPL	1500 - 3500 W
	GZRW 10XSPL	257 mm / 10.12"	228 mm / 8.98"	140 mm / 5.51"	63 mm / 2.5"	Reinforced paper	44.3 Hz	0.75	9.0 L / 0.32 ft³	2 x 2 Ω	800 W RMS / 1200 W SPL	600 - 1200 W
	GZRW 12XSPL	311 mm / 12.24"	288 mm / 11.34"	166 mm / 6.54"	75 mm / 3"	Reinforced paper	31.8 Hz	0.68	27.2 L / 0.96 ft³	2 x 2 Ω	1000 W RMS / 1500 W SPL	800 - 1500 W
	GZRW 15XSPL	387 mm / 15.24"	358 mm / 14.09"	186 mm / 7.09"	75 mm / 3"	Reinforced paper	34.1 Hz	0.59	63.3 L / 2.24 ft³	2 x 2 Ω	1200 W RMS / 1800 W SPL	1000 - 1800 W
	GZRW 30-D2	311 mm / 12.24"	288 mm / 11.34"	166 mm / 6.54"	75 mm / 3"	Reinforced paper	25.7 Hz	0.45	31.2 L / 1.10 ft³	2 x 2 Ω	800 W RMS	600 - 1200 W
	GZRW 38-D2	390 mm / 15.35"	359 mm / 14.1"	195 mm / 7.68"	75 mm / 3"	Reinforced paper	27 Hz	0.51	97.1 L / 3.43 ft³	2 x 2 Ω	1000 W RMS	800 - 1400 W
	GZRW 8FL	204 mm / 8.03"	178 mm / 7.01"	55 mm / 2.17"	36 mm / 1.42"	IMPP	45.3 Hz	0.94	17.6 L / 0.62 ft³	2 Ω	150 W RMS	80 - 250 W
	GZTW 10F	260 mm / 10.12"	232 mm / 9.13"	88 mm / 3.46"	50 mm / 2"	IMPP	38.1 Hz	0.41	27.1 L / 0.96 ft³	2 x 2 Ω	300 W RMS	150 - 450 W
	GZTW 12F	313 mm / 12.32"	284 mm / 11.18"	97.5 mm / 3.84"	50 mm / 2"	IMPP	35.1 Hz	0.53	53.2 L / 1.88 ft³	2 x 2 Ω	350 W RMS	200 - 500 W
	GZIW 10SPL	257 mm / 10.12"	230 mm / 9.06"	147 mm / 5.79"	63 mm / 2.5"	Reinforced paper	40.8 Hz	0.62	14.3 L / 0.505 ft³	2 x 2 Ω	500 W RMS / 700 W SPL	400 - 800 W
	GZIW 12SPL	310 mm / 12.2"	285 mm / 11.22"	162 mm / 6.38"	63 mm / 2.5"	Reinforced paper	36.9 Hz	0.67	35.6 L / 1.26 ft³	2 x 2 Ω	700 W RMS / 1000 W SPL	600 - 1000 W
	GZIW 165X-II	168 mm / 6.6"	147 mm / 5.79"	80 mm / 3.15"	38 mm / 1.5"	IMPP	41.5 Hz	0.45	8.6 L / 0.3 ft³	4 Ω	150 W RMS	60 - 150 W
	GZIW 200X-II	211 mm / 8.3"	182 mm / 7.17"	101 mm / 3.98"	38 mm / 1.5"	IMPP	39.9 Hz	0.56	17 L / 0.6 ft³	4 Ω	150 W RMS	100 - 200 W
	GZIW 250X-II	257 mm / 10.12"	230 mm / 9.06"	129 mm / 5.1"	50 mm / 2"	IMPP	32.7 Hz	0.49	35 L / 1.24ft³	4 Ω	250 W RMS	200 - 300 W
	GZIW 300X-II	310 mm / 12.2"	287 mm / 11.3"	149 mm / 5.87"	50 mm / 2"	IMPP	30.7 Hz	0.57	60 L / 2.12 ft³	4 Ω	350 W RMS	200 - 400 W
	GZCS 200BMW-SW	Car specific			50 mm / 2"	Pressed paper cone	59.1 Hz	1.18	15.98 L / 0.56 ft³	2 Ω	100 WRMS	80 - 160 W
	GZCS 200MB (R/L)	Car specific			35.5 mm / 1.4"	Pressed paper cone	51 Hz	0.79	15.8 L / 0.56 ft³	4 Ω	50 WRMS	40 - 100 W

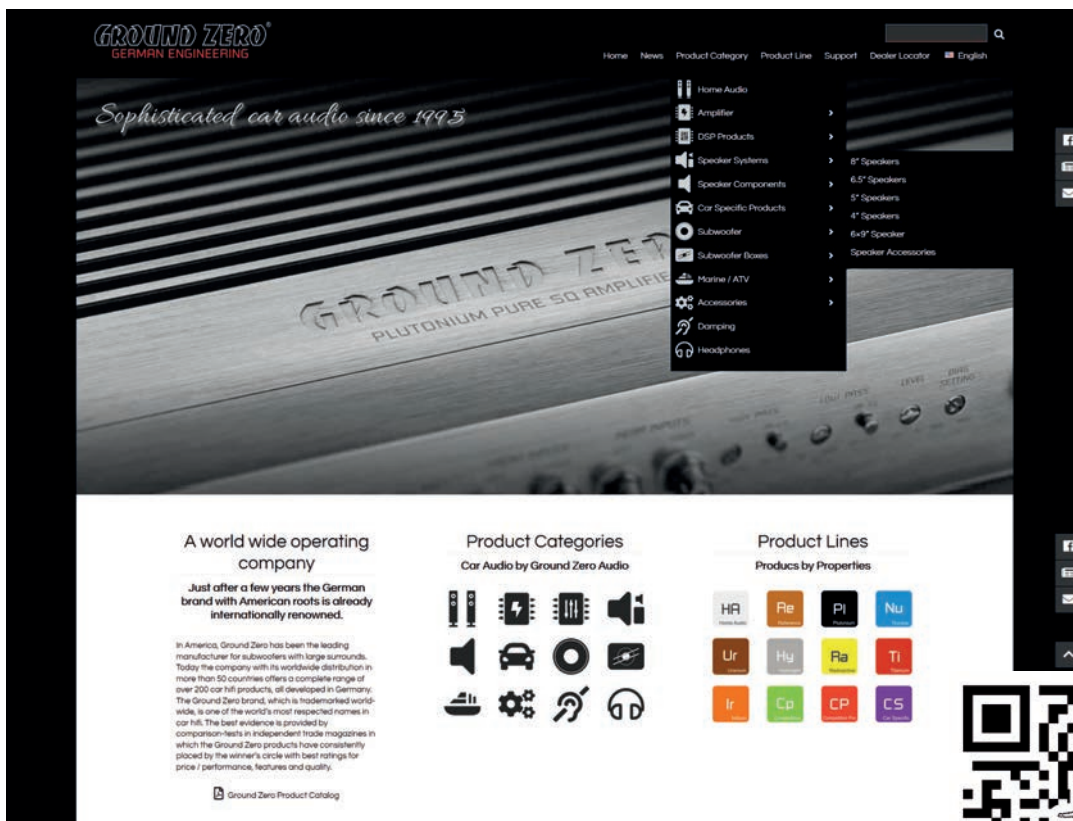

www.ground-zero-audio.com

Follow us on GROUND ZERO Official Fanpage on facebook together with more than 670.000 people from around the world!

#ShowYourGZ



facebook.com/GroundZeroAudioCom



Listening to music can be emotional, impressive, relaxing or enjoyable. At that, it doesn't really matter what kind of music is the personal favorite, whether it's Instrumental, Jazz, Electro, Latin, Classic, Rock or any other music direction. However, audio reproduction quality at each desired volume is elementary. Some music styles require higher levels while others prefer the soft tones.

GROUND ZERO considers all the different wishes of customers during the development of new products. Along with this, the target is to create the most realistic sound, to transfer the soul of the music and the intention of the performer.

Summarized to one phrase: RESPECT THE MUSIC!

RESPECT THE MUSIC



All listed brands are trademarks of the respective companies.
Errors and omissions excepted, and subject to technical changes.
Our general terms of business are applied.